

LMC

BEDIENUNGSANLEITUNG
EXQUISITE VIP
EXQUISITE BRILLIANT
EXQUISITE RS EDITION

OPERATING MANUAL

GEBRUIKERSHANDLEIDING

MANUEL D'UTILISATION

MANUAL DE INSTRUCCIONES

ISTRUZIONI D'USO

BRUGSANVISNING

KÄYTTÖOHJEET

KULLANIM KILAVUZU

操作说明

**Travel in comfort and convenience -
your home on four wheels**

Welcome to the group of caravan owners!

Congratulations on the purchase of your new LMC caravan!

You have purchased a high-quality, reliable and elegant vehicle that offers special advantages and extraordinary comfort.

Our employees extend their best wishes for your satisfaction when travelling, on holiday, or in your free-time; we are confident that you will always enjoy pleasant hours in your new home on wheels.

© LMC Caravan GmbH & Co. KG
Rudolf-Diesel-Str. 4
D-48336 Sassenberg

Tel.: +49 25 83 / 27-0
Fax: +49 25 83 / 27-138

E-mail: info@lmc-caravan.de
Internet: www.lmc-caravan.com

Version: 21.08.2024

Art. No. 2976208

Created by: gds GmbH
global document solutions
www.gds.eu

1	Introduction.....	7
1.1	Technical documentation	8
1.2	Explanation of symbols used	9
1.3	Vehicle registration.....	11
1.4	Keys	11
2	Safety.....	12
2.1	Intended use.....	12
2.2	Responsibility of the vehicle owner	13
2.3	General requirements	14
2.4	Fire safety.....	15
2.5	Traffic safety.....	16
2.5.1	Vehicle	16
2.5.2	Load	20
2.5.3	Driving.....	21
2.6	Operational reliability.....	23
2.6.1	Gas supply	23
2.6.2	Electrical system	26
2.6.3	Sanitary system	29
2.7	Environmental protection	31
3	Technical data.....	32
3.1	Caravan body	32
3.2	Built-in devices	32
3.3	Loads.....	33
3.4	Nameplate	33
4	Driving	34
4.1	Loading the vehicle	34
4.1.1	Terminology and specifications	34
4.1.2	Calculating the maximum load.....	35
4.1.3	Loading and stowing luggage	36
4.1.4	Reviewing the check list.....	37
4.2	Checking the vehicle	38
4.3	Coupling the caravan and the towing vehicle	39
4.3.1	Prerequisites for coupling	39
4.3.2	12 V power supply in towing operation	41
4.3.3	Coupling with "AL-KO" safety coupling.....	42
4.3.4	Uncoupling with "AL-KO" safety coupling	44
4.3.5	Electronic stabilisation systems	45
4.3.6	Manoeuvring assistance system Mover smart	46
4.4	Travelling and parking.....	50
4.5	Parking the caravan at the destination.....	52
4.5.1	Parking the caravan	52
4.5.2	Extending and retracting the support elements	53

5	Overview	55
5.1	Caravan body	56
5.1.1	Keys	56
5.1.2	Entrance door	56
5.1.3	Door and hatch locks	59
5.1.4	Window	62
5.1.5	Kitchen window	64
5.1.6	Combination blinds	65
5.1.7	Air conditioning system (optional)	66
5.1.8	Skylights	66
5.1.9	Pop-up roof (optional)	68
5.1.10	Awning fastening	70
5.1.11	Multifunction light switch	71
5.1.12	Exhibition lighting system	71
5.1.13	LED switches and LED displays	72
5.1.14	Smoke alarm	73
5.2	Furnishings	74
5.2.1	Sitting area	74
5.2.2	Bathroom	74
5.2.3	Kitchen area	77
5.3	Storage compartments	79
5.3.1	Storage space in the floor area	79
5.3.2	Wall cupboards	80
5.3.3	TV bracket	82
5.4	Technical equipment	83
5.4.1	Electrical system	83
5.4.1.1	Supply battery	86
5.4.1.2	Interior lighting	91
5.4.1.3	Power outlets	94
5.4.1.4	System Information Unit (SIU) (optional)	95
5.4.2	Gas supply	95
5.4.3	Heater	99
5.4.3.1	TRUMA heater 3004 S and 5004 S	99
5.4.3.2	ALDE- heater (optional)	101
5.4.3.3	Heat the floor with hot water (optional)	104
5.4.3.4	Heating the floor electrically (optional)	105
5.4.4	Fresh water and waste water system	106
5.4.5	Water heater	110
5.4.5.1	TRUMA heater and TRUMA water heater system	111
5.4.5.2	With installed ALDE heater (optional)	111
6	Camping	112
6.1	Setting up the caravan	112
6.1.1	Establishing the power connection	112
6.1.2	Filling the fresh water tank	112
6.1.3	Draining fresh water	114
6.1.4	Draining the waste water	116
6.1.5	Changing the gas bottle	118
6.1.6	Replacing the gas bottle (DuoControl CS) (optional)	119

6.1.7	Gas supply maintenance (general)	122
6.2	Airing	122
6.3	Heating and water heating	127
6.3.1	TRUMA heater	127
6.3.2	ALDE- heater (optional)	132
6.3.3	Water heater	139
6.3.3.1	TRUMA heater and TRUMA water heater system	140
6.3.3.2	With installed ALDE heater (optional)	141
6.4	Sitting and sleeping	142
6.4.1	Converting the sitting area	142
6.4.2	Folding console as bed extension	145
6.4.3	Sitting group conversion to a sleeping area	146
6.4.4	Setting up the lighting	149
6.4.5	Opening and closing the pop-up roof	150
6.5	Bathroom	154
6.5.1	Using the shower and washbasin	154
6.5.2	Flushing the toilet with fixed installed toilets (optional)	154
6.5.3	Flushing the toilet with revolving toilets (optional)	156
6.6	Kitchen area	158
6.6.1	Using the combination ceramic hob	158
6.6.2	Cooker controls	159
6.6.3	Cooking	160
6.6.4	Grilling	162
6.6.5	Baking	164
6.6.6	Folding console to extend the kitchen counter-top	165
6.6.7	Absorber refrigerator for operation with 12 V, 230 V and gas (option)	166
7	Maintenance	168
7.1	Exterior cleaning	169
7.2	Interior cleaning	170
7.3	Pop-up roof (optional)	170
7.4	Measures during lay-up	171
8	Maintenance	173
8.1	Inspection and servicing	174
8.1.1	Mileage/time dependence	174
8.1.2	Fixed time interval	175
8.2	Wheels and tyres	176
8.2.1	Changing wheels	180
8.2.2	Tyre pressure table	184
8.3	ALDE heating maintenance overview	188
9	Malfunctions	190
9.1	Caravan body	190
9.2	Electrical system	191
9.2.1	Malfunctions in standard equipment	191
9.2.2	Faults of the stand-alone package (optional)	192

9.2.3	Changing light bulbs.....	193
9.2.4	Changing the smoke detector battery	195
9.3	Gas supply.....	196
9.4	Hob	196
9.5	Heater and hot water	197
9.5.1	Malfunctions, TRUMA heater	197
9.5.2	Malfunctions, ALDE heater	198
9.6	Refrigerator.....	199
9.7	Fresh water and waste water system.....	200
10	Tightness guarantee.....	201
10.1	Guarantee certificate	201
10.2	Guarantee conditions and terms	201
10.3	Inspection schedule and inspection certificates	203
10.3.1	Overview of the extent of the leak inspections.....	204
11	Appendix.....	205
	Interior and exterior material care.....	205
12	Index.....	208

1 Introduction

Before the first trip

Your dealer will provide extensive instruction in all important functions when your vehicle is transferred to you so that you can properly operate and use your vehicle at any time.

In addition, this operating manual provides important information for using the vehicle and equipment. Carefully read this operating manual prior to using your caravan for the first time. Always comply with the instructions and safety instructions contained in this operating manual!

Strictly comply with the instructions in the accompanying operating manuals provided by the manufacturers of the built-in devices!

In an emergency situation: Help...!

If there are questions about operation, care, maintenance or repair, you can contact your nearest authorised dealer with confidence. You can find an overview of the dealers with their addresses on our homepage under the heading "Dealer search".

The dealers know your vehicle and are familiar with our latest innovations and they can provide prompt and expert assistance.

Introduction

1.1 Technical documentation

The following vehicle documents are in the document case:

Manufacturer documentation

- Operating manual with inspection booklet for leakage warranty

Supplemental documents

- Documents from the chassis manufacturer
- Device operating manual for cooker
- Device operating manual for refrigerator
- Device operating manual for heater
- Device operating manual for toilet
- Device operating manual for optional accessories
- Test certificate for the gas system with inspection tag (through the dealer)

Topicality

We continuously work on further enhancing the performance characteristics of our caravans. Thus we reserve the right to make changes in shape, equipment and technology on the vehicle compared to the information provided in this operating manual. Descriptions are for the equipment known and installed at the time this manual went to press. Consequently, no claims against the manufacturer can be derived based on the content of this manual.

Retention

The operating manual and all accompanying documents concerning the vehicle and the installed devices are considered to be a fixed component of your vehicle. They must always be accessible to all users.

Keep this operating manual and associated documents on hand in the vehicle.

Transfer all documents to the next owner if the vehicle is sold. If loaning the vehicle to a third party provide the documents to the user.

1.2 Explanation of symbols used

Safety and warning signs

Important instructions are especially marked by symbols and signal term. Comply exactly with the specified instructions to prevent personal injury, material damage and environmental damage.

DANGER



Danger to life and/or severe damage to health

This symbol combined with the "DANGER" signal term identifies an immediate hazard resulting in death or severe (irreversible) injuries.

WARNING



Severe damage to health

This symbol combined with the "WARNING" signal term identifies an imminent hazard potentially resulting in death or severe (irreversible) injuries.

CAUTION



Damage to health

This symbol combined with the "CAUTION" signal term identifies a hazard potentially resulting in slight (reversible) injuries.

CAUTION



Damage to property

This symbol combined with the "ATTENTION" signal term identifies a situation that may cause to damages to the product or objects in its vicinity.

Introduction

Tips and recommendations

NOTE



This symbol combined with the "NOTE" signal term identifies useful tips and recommendations for the efficient handling of the vehicle and its equipment.

Environmental protection

NOTE



This symbol combined with the "NOTE" signal term identifies important information regarding an environmentally conscious behaviour.

Directions

The "right", "left", "front", and "rear" directions always refer to the view in driving direction.

Dimensions and weights are rounded ("approximate" information).

Terms

Caravan, vehicle

Refers to the entire vehicle from the draw-bar to the rear lights, including chassis and caravan body.

Caravan body

Refers to the superstructure mounted on the chassis, including all systems and furnishings.

1.3 Vehicle registration

Obligation to register

Pursuant to applicable national regulations, your vehicle must be registered with the relevant authority. Registration is issued by the vehicle licensing organization of your local government.

Required documents

For registration you require:

- Registration certificate part I (vehicle registration certificate)
- Registration certificate part II (vehicle title document)
- COC document (European certificate of conformity)
- Insurance verification
- Verification of inspection (MOT certificate)
- ID card or passport
- Registration authority (if registered by a third party)
- Registration application if required

The registration certificate part II also serves as the holder's verification of ownership. Do not keep it in the vehicle!

The vehicle documents (registration certificate part I, insurance slip and MOT certificate) are considered to be the proof of authorisation for the use of the vehicle and must be carried during its use. Never store any vehicle documents in or at the vehicle!

Vehicle license

Holders are provided at the rear for attachment of the license plate.

Note that in some countries, in addition to the country code shown on the license plate, a separate nationality tag is also prescribed.

1.4 Keys

When you pick up your vehicle, you are given three keys:

- Entry door to the caravan body
- Gas locker lid
- Intake port for the fresh water tank
- Sanitary system compartment
- Additional service hatch(es) (if present)

2 Safety

This section lists all the important safety aspects for optimal protection of persons in the vehicle, and for safe and trouble-free use of the furnishings.

Moreover, the following sections include additional safety instructions for avoiding imminent dangers when using devices and equipment.

Always comply with the handling instructions specified and keep the pictograms, signs, and texts that are affixed to the built-in equipment in a legible condition.

2.1 Intended use

The caravan is designed exclusively for private habitation purposes and transport of travel luggage, and it can be used in public traffic in accordance with the provisions of the German Road Traffic Act and the German Road Traffic Registration Act.

The caravan must not be used for commercial transport of persons and/or goods.

Transporting unsecured loads and/or packed goods that are not used as travel luggage is not permitted.

Passengers are not allowed to be in the caravan when the vehicle is in motion. Every passenger must be seated in the towing vehicle with seat belts fastened during the trip.

The gross vehicle weight rating and the gross axle weight rating per axle should not be exceeded.

Any use of the caravan other than that described herein is prohibited and is considered to be improper use.

2.2 Responsibility of the vehicle owner

The vehicle has been designed and built in accordance with state of the art and in accordance with recognised safety-related rules.

Nevertheless if the instructions in the operating manual are not followed serious personal injury, significant material damage to or on the vehicle or environmental damage can occur.

Consequently the vehicle owner is obligated:

- To always keep the vehicle in technically faultless and road-safe condition.
- To exactly follow the instructions in the operating manual, and to ensure that all passengers comply with the instructions contained in the operating manual.
- To comply with the specified service intervals and to ensure that the legally prescribed tests and inspections are executed.
- To have the gas supply regularly inspected by an authorised service operation pursuant to applicable regulations.
- Not to make any unauthorised modifications to the vehicle or to the caravan body.
- To have technical problems that may adversely affect the safety of people and/or public road transport to be remedied immediately by specialist personnel.
- To always act in an environmentally responsible manner.
- To stay informed of current regulations and laws that can contain additional obligations.

2.3 General requirements

For your own safety and the safety of your passengers always comply with the following instructions:

- People must travel in the towing vehicle, and never in the caravan body.
- Travel with the caravan only when it is technically sound and fully roadworthy.
 - Prior to every trip, ensure the technically sound condition of the vehicle.
 - Always comply with the operating instructions and traffic regulations.
- Always secure the vehicle when parking and leaving.
 - Engage the parking brake.
 - Lock all doors, hatches and windows.
- Always ensure adequate ventilation of the vehicle.
 - Always ensure clear air flow through the forced ventilation openings.
 - Thoroughly ventilate the living area when cooking or heating.
- Exercise caution when using doors and hatches. There is danger of crushing injuries.
- Pay attention to passage heights when entering and exiting, and performing cleaning and maintenance work. There is danger of crushing and impact injuries.
- Always be prepared to respond to accidents.

2.4 Fire safety

Avoid fire and fire propagation!

- Always keep the smoke alarm, located in the ceiling of the caravan body, in functional condition.
 - Prior to using the vehicle for the first time, remove the protective foil from the block battery in the smoke alarm and connect the block battery to activate the smoke alarm.
 - Do not hook things into the openings on the smoke alarm housing, or cover the openings on the housing.
 - Replace the battery installed in the smoke alarm on a regular basis.
 - Replace the installed smoke alarm with a new smoke alarm every 10 years at the latest.
- Always carry an approved and tested dry-powder fire extinguisher (at least 1 kg) in the vehicle (not included in the scope of delivery).
- Always keep fire extinguisher in reach and have it tested regularly. Be aware of the test date.

Avoid fire hazards!

- Never leave children alone in the vehicle.
- Keep flammable materials away from the heater and hob.
- Never use portable heating and cooking devices.
- Never cover electrical components that can develop heat during operation (e.g. charger, electric block, lights).
- Never modify the electrical equipment or to the liquid petroleum gas (LPG) system. Have all repairs performed by qualified personnel.

Act appropriately if there is a fire!

If the smoke alarm trips or if you detect signs of a fire in the vehicle:

- Evacuate vehicle passengers without delay. If necessary provide first-aid.
- Switch off the power supply and disconnect it from the mains.
- Close the gas bottle valves.
- Secure the danger zone around the vehicle.
- Sound the alarm and call the fire department.
- Fight the fire, if this is possible without danger.

Safety

2.5 Traffic safety

Driving in public traffic always demands special caution and attentiveness. Always comply with locally applicable traffic regulations, the operating guidelines for the vehicle and the following instructions!

2.5.1 Vehicle

Dimensions and weight

Caravan and towing vehicle together comprise a rig with large dimensions and heavy weight. The driving and braking behaviour of the rig differ significantly from that of a single vehicle.

Inappropriate behaviour in road traffic - particularly by inexperienced rig drivers - can cause accidents resulting in serious or fatal injury.

Always adjust your manner of driving and comply with the following:

- Do not exceed the permissible gross vehicle weight and permissible axle load when loading the vehicle (→ nameplate)
- Compared to your car, the rig has a longer braking distance.
- If the automatic vehicle stabilization device - if present - responds, stay calm and slow down.
- Prior to driving into parking facilities, underpasses, bridges, tunnels, or vehicle decks of ferries, note the passage dimensions as well as height and width information.
- Comply with local driving restrictions or special driving instructions for caravans.
- Due to the load or attachment of accessories, dimensions, weight and driving behaviour of the caravan can change.
- When driving with the caravan attached, carry wheel chocks and use them when parking on inclines and slopes.

NOTE



Dimensions, weight and permissible load are specified in the motor vehicle registration certificate part I.

Rig operation

Risk of injury for people in the coupling area when the caravan is coupled.

Always ensure that:

- The towing vehicle has a functionally safe trailer pulling device and electrical connector coupling.
- The caravan is in an operationally safe condition, has a valid license, and is designed for the towing vehicle. Do not exceed the permissible trailer load and maximum draw-bar load (→ registration certificate part I, operating manuals for the towing vehicle and the towing device).
- Before starting your trip, ensure that the entry step is retracted
- Do not couple or uncouple caravan if the overrun brake is activated.
- Ensure that the handbrake lever has a sufficient range of movement.
- When using couplings with a removable hitch ball, ensure that the hitch ball is properly mounted (→ operating manual provided with the towing device).
- Always proceed with caution when coupling or uncoupling the caravan.
- Ensure that a helper standing away from the towing vehicle assists the driver of the towing vehicle in approaching the caravan coupling.
- Ensure that no one is in the caravan and that no one is in the space between towing vehicle and caravan.
- Enter the danger zone between the towing vehicle and caravan only when the towing vehicle and caravan are at standstill and are both secured with parking brakes.
- Immediately after coupling always check the vehicle lighting equipment and brakes on the caravan for correct function.

Safety

Wheels and tyres

Worn tyres and incorrect tyre pressures adversely affect the driving and braking behaviour of the vehicle and can cause accidents.

Always ensure that:

- Rims and tyres must be approved for the vehicle (→ motor vehicle registration certificate part I).
- Regularly (during every refuelling stop, for example) check the proper condition and correct tyre pressure of the vehicle (→ Section "Tyre pressure table")
- Immediately replace worn tyres.
- For the first trip, after every wheel fitting, and after every wheel change, re-tighten the lug nuts after 50 km (30 miles).
- During longer trips, check the lug nuts for firm seat at regular intervals.
- Tyres must not be older than six years. The same applies for spare tyres - even if they have not been used.
- Use summer tyres or snow tyres in accordance with the outdoor temperatures in the country of travel.
- Depending on the tyres, comply with the specified tread regulations.
- Prior to a longer parking period, offload the tyres (e.g. jack up the vehicle, dismount the wheels, apply a preserving agent to the tyres and store them horizontally or on a wheel tree in a dry and frost-free location).

Brakes

Defects in the braking system can cause serious accidents with fatal consequences.

Always ensure that:

- Prior to each trip check brakes for functional safety, uniform response, and directional stability. Have any defects repaired immediately by an authorised specialised workshop.
- Never make unauthorised changes to braking system components..
- Always firmly engage the parking brake when parking the vehicle.
- After a longer period of non-use (≥ 10 months), have the braking system checked by an authorised workshop.
- When travelling with a loaded caravan, on slippery roads and on routes with gradients, always drive with utmost caution and bear in mind that driving stability and braking capacity of the rig are significantly impaired.

Vehicle equipment

Mandatory equipment

- 2 Wheel chocks

Depending on the local regulations in the country of initial registration, additional equipment may be pre-installed in the vehicle. For example, vehicles for initial registration in Germany contain:

- 1 Entry step
- 1 Gas pressure regulator, 30 mbar

Recommended optional equipment

- 2 Gas bottles, filled (11 kg or 5 kg)
- 1 Water canister with spout attachment or watering can
- CEE connector cable for external 230 V connection
- Adapter set for external power supply
- Cable drum (25 m)
- Fire extinguisher (minimum 1 kg content)

Safety**2.5.2 Load**

Excessive load and improper arrangement of the load adversely affect the driving characteristics and braking behaviour of the vehicle and can cause accidents.

Always ensure that you:

- Do not exceed the gross vehicle weight rating (→ motor vehicle registration certificate part I).
- Accessories and/or special equipment options reduce the possible load.
- Never exceed the maximum permissible axle loads (→ nameplate).
- Always evenly distribute the load in the entire vehicle. Avoid placing the load on one side.
- Never place heavy objects in the cabinets or compartments so that they may suddenly shift forward when braking, performing an emergency stop, or if there is collision in the direction of travel..
- Arrange the load so that its centre of gravity is as close as possible to the floor of the vehicle. Heavy and bulky objects should be placed beneath other items.
- Secure loose and movable objects, such as luggage, adjustable tables and adjustable beds against shifting.
- Prior to starting the trip, close cabinets and hatches and lock in place. Lock refrigerator door, sliding doors, and shower doors.
- When driving at night adjust the headlight levelling control to offset the load effect.

NOTE

Information on calculating the possible load and proper arrangement of the load → Section "Loading the vehicle".

ATTENTION**Vehicle damage due to excessive roof load!**

The vehicle roof is not designed for heavy roof load and may collapse.

- Do not climb, step or walk on the roof; do not overload.
- Remove snow and ice from the vehicle's roof if parked outdoors during winter.

2.5.3 Driving

Before the trip

Unsecured load, a vehicle in a condition that is not ready to drive and/or technical defects can cause accidents with severe or fatal injuries.

Before starting your trip, always perform the following tasks:

- Remove any branches, twigs, leaves, snow or ice from the vehicle roof.
- Check that the entry step is retracted.
- Check the functioning of signalling and lighting equipment.
- Switch off the canopy light on the right side wall.
- Ensure faultless functioning of brakes and steering gear.
- Check rims and tyre tread for proper condition. Ensure that the tyres are inflated to the proper pressure.
- Securely stow luggage and loose objects. Also ensure that the load is uniformly distributed in the vehicle.
- Close and secure all inner and outer doors, service hatches, windows and skylights.
- Close and secure the pop-up top, if available.
- In the living area, close and secure cabinets, refrigerator doors and cover panels for the hob and sink.
- Lock adjustable tables and beds.
- If available, push the TV drawer back and secure. Close the hatch of the TV compartment or secure the TV drawer so that it cannot twist.
- Switch the refrigerator to internal 12 V power supply.
- Close the quick-action valves and the gas bottle valve.
- Remove the wheel chocks and retract the vehicle supports.

Safety

On the road

Failure to comply with local traffic regulations can cause accidents with serious or fatal injuries.

When driving the towing vehicle:

- Always comply with local traffic regulations.
- Always adjust your driving to current road and traffic conditions and the total weight and dimensions of your rig.
- Comply with driving restrictions for caravans.
- Always ensure that your rig does not exceed passage dimensions such as heights and widths when entering parking facilities, underpasses, bridges, tunnels or the vehicle decks of ferries.
- Never open door locks during driving.
- Avoid sudden and abrupt braking.
- Drive slowly and carefully on roads with damaged surfaces.
- Avoid bottoming out on ramps (when entering a ferry, for example), uneven surfaces, or when driving in reverse.

After the road trip

Unsecured vehicles can roll way and cause serious injury and material damage.

Always ensure the following when stopping and parking the caravan:

- Never stop or park the caravan on steep slopes, embankments or gradients.
- Firmly engage the parking brake first when parking and stopping the caravan. Then place the wheel chocks.
- On slight embankments, inclines, or slopes, place wheel chocks in front of and behind one or more wheels. Secure the wheels through the curved stop surface of the wheel chock.
- Do not use wheel chocks to compensate for uneven terrain or roads.
- Extend the supports when parking the caravan for some time.
- In winter conditions, free the vehicle of the snow and ice load. Do not exceed the permissible roof load of 75 kg.

2.6 Operational reliability

2.6.1 Gas supply

General

The gas supply system was installed, inspected and accepted according to DIN EN 1949 and a pressure and tightness was completed according to the German Association for Gas and Water DVGW worksheet G 607. Any modification of the gas supply system after delivery of the vehicle invalidates the enclosed gas test certificate and the inspection tag at your vehicle.

- In addition to the following instructions, always comply with the instructions provided for the built-in gas devices.
- Always carry the operating manuals for the gas devices in the vehicle with easy access for all parties.

Defective gas devices and supply lines may catch fire or explode and cause severe injuries. Escaping gas is a suffocation hazard. Always ensure that:

Test obligation

- Have the gas supply inspected by an authorised specialist workshop at the latest every two years. This also applies for non-licensed vehicles. Comply with local regulations.
- Do not modify the gas supply without proper authorisation. Only an authorised workshop may repair and replace gas devices.
- Regularly check the functioning of the safety pilots. Safety pilots must close the gas supply within one minute after the gas flame is extinguished (audible click).
- Check the gas hose at the pressure regulator whenever the gas bottle is exchanged. The hose should not be porous or scored.
If required, have the gas hose replaced by an authorised workshop.

Safety

Using the gas devices

- Use only tested and intact gas devices and gas bottles (11 kg or 5 kg bottles).
- Open the quick-action valve of a gas device only if the device is to be operated. Valves must be closed when the unit is not in use.
- Before using the hob, all combustible materials such as curtains, towels and clothes must be removed from the danger area.
- Open the skylight before using the gas hob.
- Do not use the hob as a space heater.
- If you smell gas or notice high levels of gas consumption, defects or other irregularities, immediately:
 - Switch off all gas devices
 - Close the main shut-off valve on the gas bottles
 - Do not smoke and do not ignite any flames
 - Do not switch on any lights or other electrical devices
 - Open windows and doors, thoroughly ventilate the interior
- Do not use butane gas for winter operation as it is only capable of gasification to 0 °C. Propane gasifies to minus 42 °C.

Gas bottles, pressure regulators and gas bottle locker

- Only connect gas bottles that are filled with propane or butane, or with a mixture of the two gases.
- Transport gas bottles only in the gas bottle locker.
- Always set up gas bottle locker vertically and strap them securely in place.
- Use only pressure regulators that are permanently set to 30 mbar output pressure.
- Always carefully connect pressure regulators as prescribed:
 - If there is a direct connection without gas pressure regulator set (optional), connect the pressure regulator directly on the gas bottle valve.
 - If you use a gas pressure regulator set (e.g. DuoComfort or SecuMotion, both optional) the pressure regulator must be mounted on the rigid permanent line. In this case, connect the gas bottle valve to the gas pressure regulator using an approved high-pressure gas hose.
- Tighten the pressure regulator or high-pressure gas hose only manually (left-handed thread!). Do not use tools.
- Gas bottle valves must be accessible at any time.
- Do not use gas bottle locker as a storage compartment.
- Never cover the forced ventilation at the gas bottle locker.
- Always secure the gas bottle locker against unauthorised access.

Driving and parking

- Prior to starting the trip, close the glass bottle valve and the quick-action valves of the gas devices.
- Do not operate any gas devices when refuelling, on ferries, in garages or parking facilities. Danger of explosion!
- Prior to extended stand times, close the glass bottle valve and the quick-action valves of the gas devices.
- After a longer period of non-use (≥ 10 months), have an authorised workshop check the gas supply system for tightness and functioning before prior to first use.

Safety**2.6.2 Electrical system****General**

The vehicle is equipped with a power supply system for:

- a. Combined operation, that is, the 230 V input via CEE-outlet and use of 230 V consumers and 12 V operators, thanks to the 12 V converted installed in the caravan.
- b. 12 V operation via the towing vehicle when the the caravan is coupled and the 13-pole outlet at the towing vehicle is fully assigned.

NOTICE

The poles 10 to 13 are frequently not assigned when the coupling system with outlet is installed at a later time.

All external lights required for road traffic are controlled as with the towing vehicle.

Emergency lighting in the caravan is also ensured (exception with stand-alone package (optional)). providing the following 12 V consumers:

- Ceiling light
- Water pump
- Toilet lighting
- Electric toilet

During driving, the system also feeds the refrigerator, starts the towing vehicle's engine and operates the generator.

NOTICE

Refrigerator operation is not possible if the 13-pole outlet is not fully assigned.

NOTICE

In towing vehicles meeting the EURO 6 standard, it can happen that the on-board computer shuts down the charging cable for the refrigerator to reduce fuel consumption.

If a stand-alone package (optional) is installed, the towing vehicle does not provide 12 V supply for the interior. In this case, the supply battery in the caravan ensures the entire supply. The entire 12 V network in the interior is available when the 12 V main switch is actuated.

During driving, the refrigerator and the supply battery are supplied with the generator's current. If the engine of the towing vehicle is shut down, you can control the refrigerator only via gas or an external 230 V supply. The refrigerator is not supplied with 12 V via the supply battery during standstill.

NOTICE



Before travelling to foreign countries, obtain information about the plug and connector systems used at your destination. Adapters are available from specialised dealers.

Touching live components can cause serious or fatal injury. Improper connection or defective electrical devices can cause fires. Always ensure that:

External power connection

- Prior to connecting, ensure that the external power supply matches the specifications of the vehicle's electrical system.
- The external power supply must be protected with a residual current circuit breaker (RCD, 30 mA).
- Use only connecting cable with the following properties:
 - Flexible CEE rubber-sheathed cable for outdoor use
 - Cross-section 3 x 2.5 mm² minimum
 - Plug connector and coupling should each have earthing contact
- Before use, check the connecting cable, plug and coupling for damage.
- The extension cable must not be longer than 25 m.
- When using cable drums, completely unroll the power cable; this prevents the cable from overheating.
- Lay the cable so that it does not cause a stumbling hazard; mark the cable routing, if necessary.

Safety

Electrical system and devices

- Connect only tested and intact devices.
- Any device exhibiting defects, faults or external damages must be immediately disconnected from the vehicle system.
- Periodic testing by an electrician.
 - Annually for frequent use
 - Every three years for occasional use
 - Half-yearly activation of the RCD test button
- Any work on the system, repairs or replacement of electrical devices must be performed by an authorised workshop only.
- Prior to starting any work on the system, switch off all electrical consumers, such as lights, TV, radio and other devices; disconnect the external power supply and disconnect the supply battery (if present).
- Check the function of the integrated residual current circuit breaker in the fuse box at regular intervals.
- Never bridge, manipulate or repair any miniature circuit breaker or safety fuse.
- Replace defective fuses only after the cause of the fault has been identified and rectified.
- Replace defective fuses only with new original fuses with prescribed ampere rating.

2.6.3 Sanitary system

As standard, the caravan comes with a freshwater canister and a toilet.

WARNING



Health hazards due to chemicals!

Harmful chemical cleaning agents are required for toilet hygiene.

- Comply with the manufacturer's instruction on the packaging and use with caution.

ATTENTION



Damages after extended stand time or frost!

If the vehicle is not used in winter, the sanitary system may be damaged due to frost.

Extended stand times can cause algae growth in the sanitary system.

- Ensure that the overflow valve is free from contamination and ice formation.
- In the event of frost or extended stand time, completely empty the water tanks, containers, hoses, and conduits. Dry-run the pump for approximately five minutes to avoid frost damage caused by residual water in the pump.

NOTE



Waste water, solid waste and chemical substances can cause significant environmental damage.

- *Drain the waste water and solid waste tank only at designated disposal points.*

Safety**Hygiene****WARNING****Health hazard due to germs and bacteria in the drinking water!**

Contaminated drinking water can cause serious infections.

- Prior to the first use, disinfect the fresh water system of the vehicle, and thoroughly flush with drinking water.
- Transfer water only from supply systems with proven drinking water quality.
- Filling hose and container must be approved for drinking water.

-
- Fresh water becomes undrinkable very quickly! Prior to every start-up, thoroughly flush the fresh water tank, the lines and water cocks with plenty of tap water.
 - Regularly sterilise the fresh water tank. Special sterilizing agents are available from specialised dealers. Comply with the manufacturer's instructions specified on the packaging of the sterilising agent, and with local application guidelines and fresh water regulations.
 - Wear hygiene gloves (from specialist suppliers) when handling the waste water tank and the solid waste container; and thoroughly cleanse any exposed skin.
 - Drain waste water and solid waste tanks only at designated disposal points, never in nature. If needed, information about the nearest disposal station can be obtained from the municipal administration.

2.7 Environmental protection

Cleanliness

Real camping enthusiasts always leave their stopover clean and tidy. Always behave in such a manner that you will be welcomed back!

Many towns and communities offer designated and well-equipped compounds with all necessary supply and disposal facilities for caravans.

Waste

Separate glass, plastic, paper, and kitchen waste, and dispose of waste in the containers provided for the various recyclable materials. If necessary, contact municipal authorities for information on disposal possibilities.

Please note: Do not dispose of household waste in the waste containers provided at rest stops and parking facilities!

Waste water

Do not dispose of waste water in street drains or in free nature!

Always empty waste water and solid waste containers in designated disposal points in camping grounds or specifically equipped communal compounds.

Toilet chemistry

Use only environment-friendly and biodegradable WC chemicals.

Technical data

3 Technical data

General

This section contains a selection of important technical data. A complete overview of all technical specifications is provided in the price list and the enclosed operating manuals of the devices installed.

3.1 Caravan body

Specification	Value	Unit
Freshwater canister	12	l
Filling volume, fresh water tank ¹⁾	44	l
Intake volume, grey water tank ¹⁾	25	l
Capacity, supply battery ¹⁾ , at least	60	Ah

¹⁾ Special option (See also "Special Options → chapter "Overview").

3.2 Built-in devices

The technical data of the built-in devices are provided in the respective operating manuals. These are in the document case. Depending on the selected fittings, they include the documentation for:

- Kitchen appliances (e.g. refrigerator, oven, grill)
- Heater, boiler, sanitary system
- Electric control, storage battery, charger
- Optional equipment (e.g. grill)

3.3 Loads

ATTENTION



Vehicle damage due to excessive roof load!

The vehicle roof is not designed for heavy roof load and may collapse.

- Do not climb, step or walk on the roof; do not overload.
- Remove snow and ice from the vehicle's roof if parked outdoors during winter.

Depending on the selected equipment your caravan is equipped with different load units.

The maximum permissible load of these components is:

Load unit	Max. weight
Gas locker	50 kg
Bunk beds	80 kg
Folding beds	50 kg

3.4 Nameplate

The nameplate is affixed in the front storage compartment. The chassis number has been also stamped into the right draw-bar strut below the superstructure.

The nameplate must be neither modified nor removed. It must always be in legible condition.

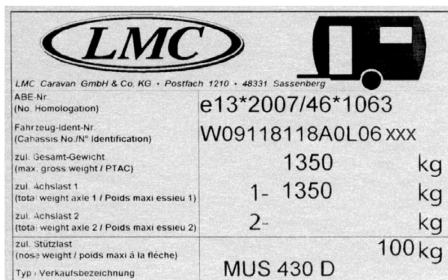

Fig. 1: Nameplate

The nameplate contains the following information (from top to bottom):

- Manufacturer
- ETG No.
- LMC Chassis No.
- Permissible total weight
- Permissible axle load, axle 1
- Permissible axle load, axle 2
- Permissible bearing load
- Type designation

Driving

4 Driving

Fundamentals

When driving your caravan, always comply with the regional traffic regulations and laws. Carefully plan your route in advance. Drive carefully and in an environmentally responsible manner.

Bear in mind that your rig has dimensions and weight that are significantly greater than those of a car. Always remember that towing a caravan is subject to additional regulations.

towing a caravan is described in the operating manuals of many towing vehicles. Always keep this operating manual on board for easy access for anyone driving the vehicle. Comply with the information and the handling instructions provided in the manual.

In addition, always comply with the instructions specified in the "Safety" section of this manual.

4.1 Loading the vehicle

4.1.1 Terminology and specifications

Technically permissible total weight	Total vehicle weight that must not be exceeded. Provided in → Registration certificate Part II
Weight in ready-to-drive status	Unloaded weight including weight of the basic equipment required for proper use and to drive the vehicle, (including fresh water, gas, wheel chocks, cable drum, etc., without optional equipment). Provided in → Registration certificate Part II
Load	Mass of all objects carried including luggage, personal items and properties, and the optional equipment.
Optional equipment	Accessories offered by the manufacturer beyond the standard equipment and that may be either ordered with the vehicle or installed at a later time, such as satellite dish, oven, air-conditioning.

Personal items

Weight of all items carried in the caravan not contained in the aforementioned list, such as foodstuff, crockery, radio, TV, clothing, bedding, toys, books, toiletry articles, bicycles, boats, surfboard, sport equipment. These objects must be taken into account in any event, regardless of where they are stored.

For personal items, you may use a ballpark figure of 20 kg per person plus 10 kg per metre of vehicle length, if the actual individual requirement does not significantly differ from this value.

4.1.2 Calculating the maximum load

Sample calculation

Specification	Value
Technically permissible total weight	1600 kg
of which the mass in ready-to-drive status (including basic equipment such as gas, fresh water)	- 1350 kg
The maximum load is	= 250 kg
Personal items (for four persons with 20 kg each)	+ 80 kg
General equipment (10 kg per metre caravan body)	+ 50 kg
Special options	+ 35 kg
The general load is	= 165 kg
Remaining possible residual load	= 85 kg

Driving

4.1.3 Loading and stowing luggage

Prior to loading the vehicle, check the location and arrangement of storage spaces in the vehicle (→ section "Storage spaces"). Follow the instructions in the "Safety" section!

Distribute the luggage properly.

1. Ensure that all weights are correctly taken into account.

NOTE



Do not forget to add all books, leisure and sport equipment, foodstuff, etc.

2. Evenly distribute the luggage items according to their individual weights:
 - Taking the maximum axle loads into account, place heavy items (such as tent hardware and canned goods):
 - in lower placed storage lockers with doors not opening in driving direction, or
 - securely attached to the floor in the living area to prevent movement.
 - Store light objects (garments) in the built-in wardrobe and the hinged compartments.

4.1.4 Reviewing the check list

Before the trip, review all required travel documents and equipment using the following list.

Amend this list to meet your specific requirements.

Checks

- All vehicle documents are on board (operating manuals for caravan, towing vehicle, installed equipment and devices)
- Motor vehicle registration certificate, part I carried by the driver
- Certificate of insurance on board
- Travel documents for all passengers on board
- Currencies of transit countries and destinations on board
- Trip route, road maps, country information on board
- Luggage completely and properly stored
- Veterinary certificates required for transit countries and destinations, for pets on board.
- Road regulations for caravans in the transit countries and destinations are known

Driving

4.2 Checking the vehicle

WARNING



Danger of accident and injury due to vehicle defects!

Defects on and in the vehicle can cause accidents with severe to fatal injuries as the consequence.

- Prior to every start, check the vehicle and the load for condition and driving safety.

Copy (and amend, if necessary) the following list to meet your needs and tick each line when the respective list item has been completed, before starting your trip.

Tasks and checks that must be executed immediately before starting the journey	✓
1. Free vehicle, particularly the roof, from deposits such as branches, twigs, leaves, snow, and ice.	
2. Check the functioning of signalling and lighting equipment.	
3. Switch off the canopy light on the right side wall.	
4. Ensure faultless functioning of brakes and steering gear.	
5. Ensure that the handbrake lever has a sufficient range of movement.	
6. Check rims and tyre tread for proper condition. Ensure that the tyres are inflated to the proper pressure.	
7. Check load for proper distribution and fastening.	
8. Close and secure all inner and outer doors, service hatches, windows and skylights.	
9. Close and secure the pop-up top, if available.	
10. If fitted, move the lift-up bed into the upper holding position prior to travel.	
11. Close and secure cabinets, refrigerator doors and cover plates for hob and sink.	
12. Lock adjustable tables and beds.	
13. Push in and secure TV stand. Close the hatch or secure the stand against twisting.	
14. Switch the refrigerator to internal 12 V power supply.	
15. Disconnect the external 230 V power supply with CEE plug.	
16. Close gas bottle valves and quick-action valves.	
17. Remove the wheel chocks and retract the vehicle supports.	

4.3 Coupling the caravan and the towing vehicle

4.3.1 Prerequisites for coupling

Safety

WARNING



Risk of injury when moving or standing between caravan and towing vehicle!

If the towing vehicle is moved backward, persons positioned between the vehicles can be caught between the vehicles and severely injured.

- Never remain between the vehicles when the towing vehicle is reversed.
- Provide the driver with directions and signals during reversing. Be aware of persons in the vicinity or approaching the vehicles.
- Wait with establishing the connection between the two vehicles until the towing vehicles has closely approached the coupling system of the caravan, shut down the engine, and engaged the parking brake.
- You may optionally push the caravan toward the towing vehicle.

ATTENTION



Damage to property when permissible values are exceeded

The towing vehicle and/or the caravan may be damaged when permissible values are exceeded during coupling.

When coupling, ensure that the following values are not exceeded:

- Permissible axle load
- Permissible support load
- Permissible rear axle load of the towing vehicle
- Permissible total weight of towing vehicle plus caravan

Refer to the documentation of the towing vehicles and the caravan nameplate for the permissible values.

Driving

The design of the coupling system depends on the caravan model and the selected equipment.

Additional information on handling the caravan coupling is supplied in the accompanying operating manual provided by the manufacturer.

- Before using the caravan coupling for the first time, note the instructions in the manufacturer's operating manual, particularly the safety instructions!

Prerequisites

Coupling prerequisites:

- The support wheel must be lowered to the ground and secured so that it bears the draw-bar load.
- The parking brake of the caravan is engaged.

4.3.2 12 V power supply in towing operation

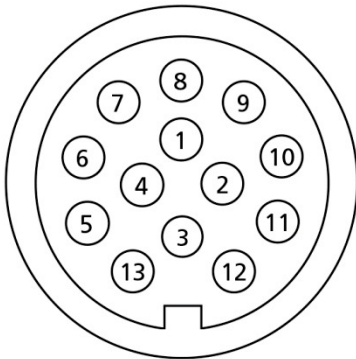

Fig. 2: 13-pole plug

13-pole plug

The 12 V-power supply of the caravan in coupled condition is ensured only when the towing vehicle and the caravan are connected via a 13-pole plug.

Contact No.	Power circuit	Wire Ø in mm / colour
1 / L	Indicator left	1.5 / yellow
2 / 54 g	Rear fog lamp	1.5 / blue
3 / 31	Earth (for power circuit contacts 1-8)	1.5 / white
4 / R	Indicator right	1.5 / green
5 / 58 R	Right rear lamp, outline lamp, side light and license plate lamp	1.5 / brown
6 / 54	Brake lights	1.5 / red
7 / 58 L	Left rear lamp, outline lamp, side light and license plate lamp	1.5 / black
8	Reversing light	1.5 / pink
9	Power supply (steady plus)	2.5 / orange
10	Charge cable plus (refrigerator)	2.5 / grey
11	Earth (refrigerator)	2.5 / white/black
12	Coding for coupled caravan (free)	1.5 / white/blue
13	Earth (for power circuit contact 9)	2.5 / white/red

Information

NOTICE



It must be ensured that the towing vehicle makes available sufficient power for the safe operation of 12 V consumers in caravans when driving. With some vehicles it is possible that the battery management of the towing vehicle switches off consumers to protect the battery. Contact your vehicle manufacturer for more information.

Driving

4.3.3 Coupling with "AL-KO" safety coupling



Fig. 3: Basic position

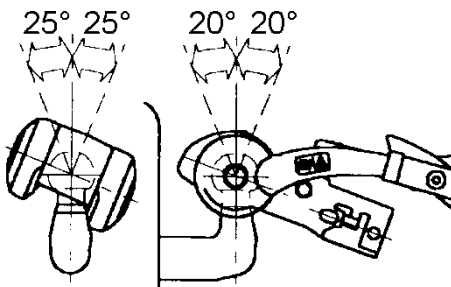

Fig. 4: Maximum swivel range of the ball coupling on the coupling ball of the towing vehicle.



Fig. 5: Tow-ball coupling open

- 1 Coupling handle, position open
- 2 Stabilising lever, open

WARNING



Danger of accident and injury if the caravan becomes detached!

If improperly coupled, the caravan can become detached from the towing vehicle and cause serious accidents with fatal consequences.

- The coupling ball on the towing vehicle must be free of grease and other residue.
- Immediately replace any friction linings that are fouled with grease; do not attempt to clean them.
- Do not exceed the maximum permissible swivel range of the tow bar coupling.
- After each coupling action, check the coupling for correct seat and solid, secure connection of the rig vehicles.

- Maximum permissible vertical swivel range: $\pm 20^\circ$
- Maximum permissible horizontal swivel range: $\pm 25^\circ$

Coupling process

1. Release the parking brake on the caravan and position the caravan with the tow-bar coupling precisely above the trailer ball of the towing vehicle.
2. Engage the parking brake.
3. Pull the coupling handle (1) upward.
4. Slowly crank down the support wheel, while placing the opened tow-ball coupling on the towing coupling of the towing vehicle.

NOTE



Due to the draw-bar load, the tow ball coupling engages automatically and audibly and the coupling handle returns to the initial position.

5. Use your hands to firmly press the coupling handle (1) downward.
6. Check the coupling for firm seating.
The tow-ball coupling is correctly coupled if the green edge of the safety display (\rightarrow Fig. 6) is visible.
7. Place the brake away cable of the towing vehicle around the coupling of the towing vehicle and hook the cable's spring hook onto the cable itself.



Fig. 6: Safety display

8. Insert the electrical connector plug of the caravan into the towing outlet on the towing vehicle.
9. Check the lights (rear light, brake lights, blinkers, reverse light, clearance lights) on the caravan.
10. Release the parking brake before starting the trip.
11. Ensure that the handbrake lever can be moved up and is not obstructed by a bicycle mounted on the draw-bar.

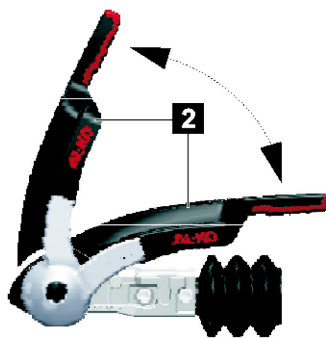
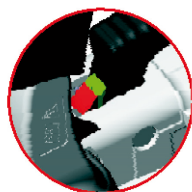

Fig. 7: Wear indicator

Wear indicator

1. Couple the caravan to the towing vehicle.
2. Open the stabilising lever (/2).
3. Close the stabilising lever (2) until resistance is noticeable, (friction linings rest on the trailer ball of the towing vehicle, however, they are not yet tensioned.).



Visible green mark:

- Front and rear friction linings are okay
- Coupling ball okay

Green mark no longer visible:

- Front and rear friction linings worn → Replace friction linings
- Coupling ball $\varnothing < 49$ mm



Arrow position	Condition
Arrow below mark 1-green	New status
Arrow above mark 1-red	Left and right friction linings worn → Replace friction linings
Arrow at mark -2	AKS closed

Driving

4.3.4 Uncoupling with "AL-KO" safety coupling

NOTE



When uncoupling the caravan, the overrun device must be relaxed and the bellows must be extended.



1. Engage the parking brake of the caravan.
2. Detach the contact breaking cable and remove from the towing vehicle.
3. Remove the electric connection plug from the towing vehicles and securely store in the plug receptacle in the caravan draw-bar to prevent moisture.
4. Lower the support wheel to the ground, secure and crank down until the caravan's draw-bar slightly lifts.
5. Pull up the stabilising lever (2) to the stop.
6. Pull the coupling handle (1) upward and hold.
7. Crank the support wheel further until the coupling bell fully lifts from the towing ball of the towing vehicle.
8. Reset coupling handle (1) and stabiliser lever (2) to their start positions.

Fig. 8: "AL-KO" safety coupling

4.3.5 Electronic stabilisation systems



Fig. 9: Electronic stabilisation system

Electronic stabilisation systems continuously monitor the running behaviour of the caravan.

In driving conditions causing the caravan to swerve, the lateral acceleration, sensors of the ATC control electronic capture even minuscule lateral movements. The system immediately slows the caravan without driver intervention. Some few seconds of braking are sufficient to return the rig into a safe driving condition.

- Refer to the attached operating manual of the manufacturer.

NOTE



The running speed must always be matched to the weather, road and traffic conditions, irrespective of the fitted assistance system.

Actions prior to attachment of the 13-pin connector to the towing vehicle:

- Release the parking brake.
- Check for an extended overrun device!

After the 13-pin plug is plugged in on the towing vehicle, the system starts a self-test. Then the LED should light up in green.

Driving

4.3.6 Manoeuvring assistance system Mover smart

The Mover is a manoeuvring system with which a caravan can be moved without assistance from the towing vehicle.

The Mover smart M was designed for use on single-axle caravans with a gross weight of up to 1800 kg and the Mover smart A (optional) was designed for single-axle caravans with a gross weight of up to 2000 kg.

NOTE



The manoeuvring system must only be used on camp-sites and private land.

Use of the manoeuvring system on public roads is strictly forbidden!

A 95 AH GEL battery is used for the power supply.

Observe the instructions for battery care!

After each use of the Mover, the power supply must be isolated using the battery isolator!

Remote control

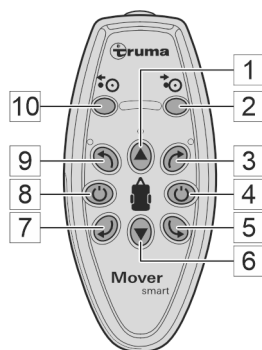

Fig. 10: Mover smart remote control

- 1 Drive caravan forwards
- 2 Swivel Mover in (Mover smart A only)
- 3 Rotate the caravan clockwise (via the right axle)
- 4 Switch off (red) / emergency stop switch
- 5 Rotate the caravan anticlockwise (via the right axle)
- 6 Reverse caravan
- 7 Rotate the caravan clockwise (via the left axle)
- 8 Switch on (green)
- 9 Rotate the caravan anticlockwise (via the left axle)
- 10 Swivel Mover out (Mover smart A only)

Start Mover up



Fig. 11: Socket on the tow bar

1. Create power supply to the Mover via the battery isolator.
2. Secure the caravan to prevent it rolling away (apply handbrake).
3. Pull out the 13-pin plug from the towing vehicle and plug into the socket on the caravan's tow bar

Swivelling in

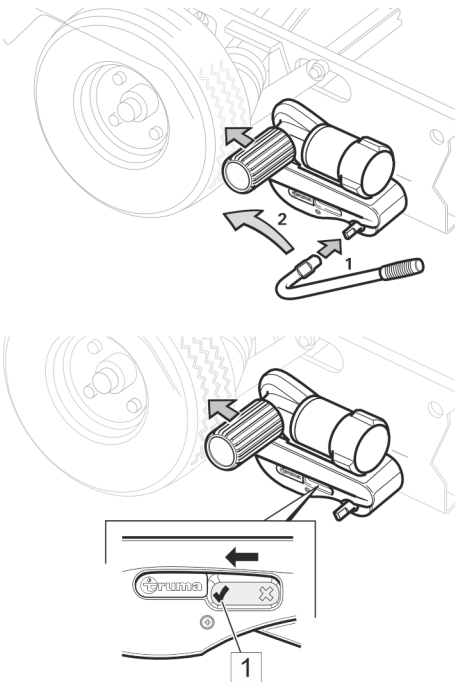

Fig. 12: Swivelling Mover smart M in

Mover smart M

1. Push the swivel in wrench onto the swivel shaft.
2. Turn the swivel wrench in the direction of the tyre until the drive roller is firmly seated on the tyre, and in the housing the position indicator is set to (1). In the limit position, the drive unit engages securely. This must be checked on both sides prior to any manoeuvring.
3. Take the swivel wrench off.

Mover smart A

1. Switch on the remote control.
2. Press the remote control button for swivelling in for about five seconds and then release it. The drive roller swivels in.

The remote control indicator flashes during this process. The process is only complete after the indicator stops flashing, and only then can the remote control send new commands.

Driving

Manoeuvring the caravan

1. Prior to manoeuvring, release the handbrake and/or remove any chocks or similar.
2. The remote control "Switch off" button also functions as an "Emergency stop switch". If abnormalities occur, e.g. uncontrolled behaviour of the Mover, the "Switch off" button must be pressed immediately.
3. The direction buttons are used to move the caravan in the desired direction.
 - If the opposing direction buttons are pressed simultaneously, the caravan rotates around its own axis in the respective direction.
 - During movement (forwards/reverse) the direction of travel can be changed using the direction buttons.
 - When the buttons are released, or when there is interference with the radio signal or it is too weak, the caravan stops. Radios or other Mover remote controls do not operate the Mover.
 - After starting off, the Mover moves with a steady speed. The speed increases slightly on a downhill slope or decreases slightly on an uphill slope.
 - Due to the system, the speed increases on slopes. The speed can be reduced by more frequent stopping and restarting.
4. After manoeuvring, first apply the handbrake or secure the caravan against rolling away, then deactivate the Mover.

Swivelling out

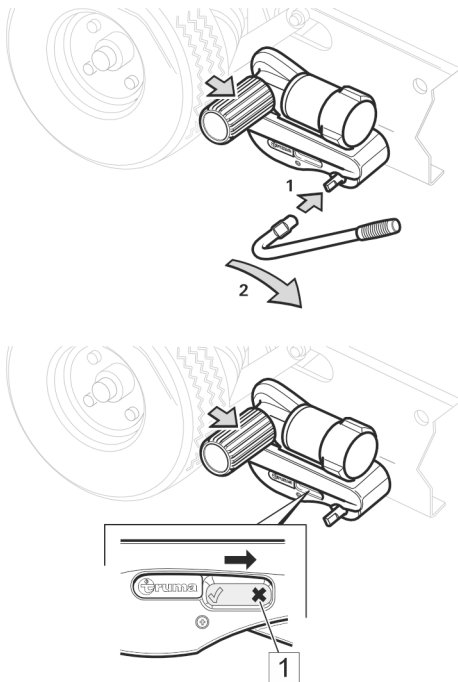

Fig. 13: Swivelling Mover smart M out

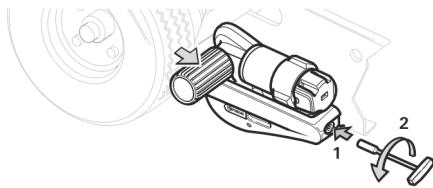

Fig. 14: Swivelling Mover smart A out manually

Mover smart M

1. Push the swivel in wrench onto the swivel shaft.
2. Turn the swivel wrench in the direction opposite to that of the tyre until the drive roller securely engages in the limit position. The position indicator in the housing is now set to (1).
3. Take the swivel wrench off.

Mover smart A

1. Create power supply to the Mover via the battery isolator.
2. Switch on the remote control.
3. Press the remote control button for swivelling out for about five seconds and then release it. The drive roller swivels out.

The remote control indicator flashes during this process. The process is only complete after the indicator stops flashing, and only then can the remote control send new commands.

The Mover smart A can also be swivelled manually if there is no power or a malfunction prevents automatic swivelling.

1. Secure the caravan to prevent it rolling away!
2. Disconnect the power supply to the Mover via the battery isolator.
3. Remove the cover cap from the back of the Mover.
4. Insert the 8 mm socket into the opening and **manually** turn anticlockwise until the Mover will not swivel any further.
5. Repeat the procedure for the other tyre.

NOTE



For more information on the Mover, see the device operating manual.

Driving

4.4 Travelling and parking

Travelling

WARNING



Risk of injury and accident due to incorrect behaviour!

The rig comprised of towing vehicle and caravan has large dimensions and a great weight. Incorrect behaviour can result in accidents with serious or fatal injury as the consequences.

- Remember changed driving properties, longer braking distance, higher total weight, and larger dimensions when driving the rig.
 - Always adjust your driving style to the current road and weather conditions.
 - Comply with local traffic regulations.
 - Comply with specific regulations for rigs in transit countries and destinations.
-

Parking**WARNING****Risk of injury due to an unsecured vehicle!**

Unsecured vehicles can roll away and cause serious injury or material damage.

- Never stop or park the caravan on steep slopes, embankments or gradients.
- When stopping or parking the vehicle, always secure with wheel chocks against uncontrolled rolling away.

-
1. Turn off the engine of the towing vehicle.
 2. Put the vehicle in gear. For a towing vehicle with automatic transmission, place the selection lever in park position "P".
 3. Firmly engage the parking brake of the towing vehicle.

If the caravan is parked without towing vehicle:

1. Firmly engage the parking brake of the caravan.
2. On slight inclines, slopes, or embankments, place wheel chocks in front of and behind one or more wheels of the caravan.

NOTE

Do not use wheel chocks to compensate for uneven terrain.

Driving

4.5 Parking the caravan at the destination

4.5.1 Parking the caravan

Selecting a parking place

For optimal and trouble-free use of all technical vehicle equipment, select the parking place in accordance with the following criteria:

- Stable, horizontal, level surface.
- Electrical mains connection in the immediate vicinity (maximum distance: 25 metres).
- Fresh water and waste water connections as well as approved disposal station in the immediate vicinity.
- Adequate parking space dimensions ensuring that all doors and maintenance hatches are accessible after parking the caravan.

Parking the caravan

1. Uncouple the caravan, push it to the parking space and align it in the desired position.
2. Firmly engage the parking brake.
3. Place wheel chocks, if necessary.

NOTE



Do not use wheel chocks to compensate for uneven terrain.

-
4. Extend the corner support elements

4.5.2 Extending and retracting the support elements

WARNING



Crushing hazard when extending or retracting the support elements!

Extending and retracting support elements can cause feet, hands, or other body parts to be crushed and injured.

- Do not position yourself in the swivel area of the supports.
- Do not tamper with support elements.

NOTE



On soft, yielding surfaces, place large plates under the supporting elements before extending to prevent them from sinking into the ground.

NOTE



The supporting elements do not serve as vehicle jacks, rather they are used exclusively to stabilise the vehicle.

When extending, load all supporting elements uniformly.

To compensate for inclines use special drive-on wedges that are commercially available!

Driving

Extending the prop

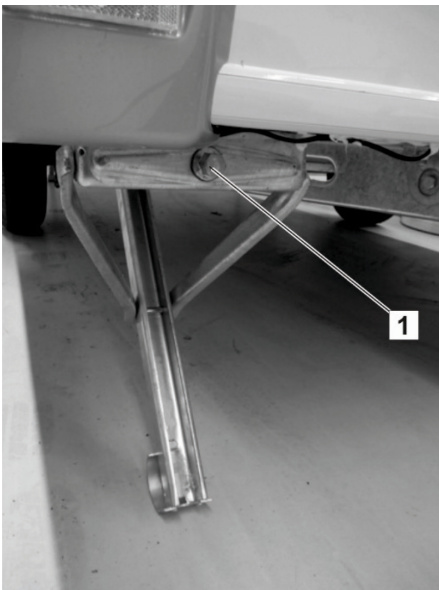

Fig. 15: Hexagonal bolt (1) for socket wrench

1. Place the socket wrench from the gas bottle box on the hexagonal bolt (1) at the front right caravan corner.
2. Turn the socket wrench clockwise until the support element rests firmly on the ground.
3. Extend the support element on the left front side of the caravan in the same manner. Use the two front support elements to align the caravan horizontally and bring it into a stable position.
4. Extend the rear corner support elements. Align the vehicle as described for the forward support elements and bring the vehicle to a stable position.
5. Once all 4 support elements are correctly extended and the caravan is stabilised, return the socket wrench to its holder in the gas bottle box.

Retracting the support element

WARNING



Danger of injury due to improperly retracted support elements!

Support elements that are not properly retracted can cause accidents, severe injury and material damage. Therefore:

- Prior to starting each trip, ensure that all support elements are properly retracted.

1. Place the socket wrench from the gas locker in the hexagon of the threaded rod at the front right caravan corner.
2. Turn the socket wrench counter clockwise until the support element is completely retracted to the stop.
3. Repeat steps 1 and 2 with the other support elements.
4. Withdraw the socket wrench and store it in its holder in the gas locker.

5 Overview

General

This section provides an overview of the caravan body and its equipment. The arrangement and important control elements of the built-in devices are explained.

NOTE



Some of the built-in items described here are only available on express special option, or as accessories. These equipment elements are only in your caravan body if they were specifically requested when the vehicle was ordered.

Several equipment elements are presented as examples, or are presented in different model variants in the descriptions below. The variant actually installed the vehicle in these cases always depends on the model or price, and due to its design cannot always be replaced with a different variant. Claims to equip the vehicle with a specific variant cannot be derived from this operating manual.

■ Optional equipment

Optional equipment (identified below by "(optional)") directly affect the design, manufacturing and price of a vehicle and, in most cases, it cannot be retrofitted or installed at a later time. Optional equipment requirements that are not directly listed in the purchase contract cannot be derived from this operating manual.

A binding list of the standard equipment in your vehicle is shown in the price list used when your vehicle was ordered.

Overview

5.1 Caravan body

5.1.1 Keys

With your caravan you receive three copies of the same key. This key can open the following locks:

- Entrance door and intake port for drinking water
- Service and storage hatches on the outside of the caravan

5.1.2 Entrance door



Fig. 16: Entrance door with window (example)

Entrance door with window

The entry to the living area is on the right side of the vehicle.

The entrance door can be locked from the outside with a safety lock that can also be locked and unlocked from the inside.

An awning light (optional) illuminates the entry area at night.

A waste container can be found on the inside of the entry door. Sliding blinds are installed on the inside of the door's window.

Optionally, the entrance can be provided with a fly-screen door, which is attached on the inside of the side wall. When the fly screen is drawn across, it allows the vehicle to be ventilated while the entry door is open while keeping insects away from the interior.

CAUTION



Damage due to incorrect use!

When entering and exiting the vehicle and when closing the entrance door, the fly screen may be damaged by the waste container.

- Always return the extended fly screen back into the holder first!

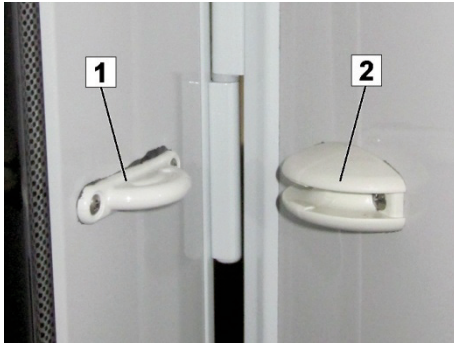

Fig. 17: Door and hatch locks

Entrance door and large hatches can be locked in open condition. This prevents unintentional slamming of doors and hatches i.e. by the wind.

- To hold the door or hatch in place, carefully open the door until the stop and then press it lightly against the holder until the catch lock (1) engages in the receptacle (2).
- To release, pull the door or hatch out of the holder with a light jerk.

Exterior door lock, body door



Fig. 18: Door lock

- To open the entry door, unlock the door lock with the key, reach into the recessed grip and pull the door to the outside.

Overview

Interior door lock, body door



Fig. 19: Closed but unsecured door lock

Opening and closing the entrance door

To lock and secure the entrance door from inside:

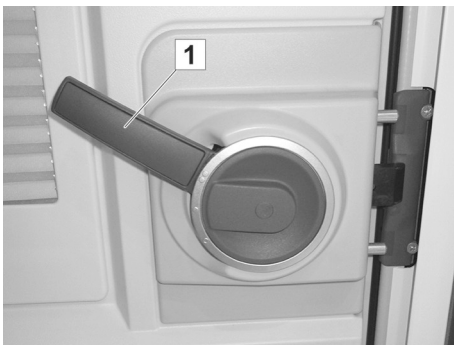

Fig. 20: Lever in top position

1. Turn lever (1) to top position

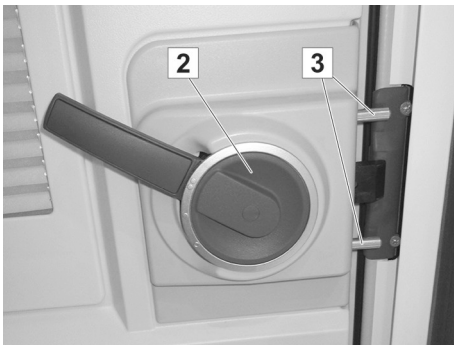

Fig. 21: Door closed and secured

2. Rotate inner knob (2) upward until two pins (3) protrude to additionally secure the door.



Fig. 22: Door lock open

- To open the door, simply push the lever downward

5.1.3 Door and hatch locks

CAUTION



Open hatches can cause damage!

Open hatches can hit street signs, light poles, and other obstacles while driving and cause severe damage to the vehicle and third-party properties.

- Never drive with opened hinged windows/hatches!



Fig. 23: Service compartment on the outside of the caravan

Depending on the model and selected equipment, hatches are located on the outside of the caravan. e.g.: accesses to rear external storage locker, hot water tank, to small storage compartments (for vehicle accessories, tools, car jack) and for the toilet waste holding tank.

NOTE



Always keep hatches closed. This will prevent loss of equipment and theft!

Overview

Service compartment lock

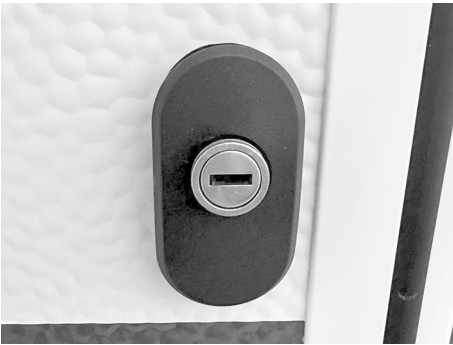

Fig. 24: Service compartment lock

The service locks can be operated with the body door key. They are not operated via remote control.

Opening the service compartment:

- Use the key to unlock the lock and rotate the knob clockwise through 90°. In this position, the contact pressure abates but the service compartment cannot yet be opened.
- To open the service compartment, rotate the knob clockwise by another 90°.

Closing the service compartment:

You can re-engage the lock in opened conditions. Then, after closing the hatch, it is only necessary to turn it back through 180 degrees and press it in so that it locks again.

ATTENTION



Property damage due to inserted keys!

Keys that are not removed can cause severe scratches in the outer shell of the caravan body. Keys can break off.

- Always remove the key immediately after opening or closing locks.
-

Gas cylinder box, EXQUISIT VIP



Fig. 25: Gas bottle locker lock



Fig. 26: Gas bottle locker lid, open

The gas bottle locker is located in the front above the draw-bar. The gas bottle holder and the gas pressure regulator are located here.

NOTE



Depending on the selected equipment, a gas pressure regulator set (optional) with automatic switch-over function can be pre-mounted.

- The lock for the gas bottle locker enclosure is located behind the cover.

Open lid:

- Raise cover.
- After opening the lock, the knob springs out.
- Turn the knob to the right to unlock the gas bottle lid.
- Reach into the recessed grip and press gas bottle locker lid upwards.

Close lid:

- Press the gas bottle locker lid down.
- To lock the gas bottle locker lid, press down and lock with the button.

This is particularly useful if a bike holder is mounted on the draw-bar and bicycles are attached to the bike holder. In this case, you don't need to remove the bicycles in order to close the gas bottle valve when refuelling or after cooking, for example.

Lock on the fresh water intake port



Fig. 27: Fresh water intake port

The lock for the fresh water fill intake port is located directly in the closure cap.

- To open, or close, hold the closure cap firmly and turn the lock 180°.

Overview

5.1.4 Window

Hinged window



Fig. 28: Framed hinged window

The living and sleeping area features large hinged windows designed to provide superior ventilation.

- To open, turn the sash fastener fitted at the lower frame and slightly push the window to the outside until the support arms latch. Three positions can be selected for the width of the opening.
- To close the window, swing fully to the outside and then slowly pull downward. Finally, return the sash fastener to the locked position.

CAUTION



Open windows can cause material damage!

Projecting windows can hit signs, light poles, and other elements during driving, and cause severe damage to the vehicle and other property.

- Never drive with opened hinged windows!
-

Correct locking of the hinged windows before any journey

Depending on the floor plan, the vehicles are equipped with different types of hinged windows.

The sash fasteners of the hinged windows have three positions:



Fig. 29: Open position

In the open position, the sash fastener is not against the clamping block.



Fig. 30: Ventilation position

In the ventilation position, the sash fastener is positioned centrally in the clamping block.



Fig. 31: Closed position

In the closed position (sash fastener position for driving) the sash fastener is located on the inside of the clamping block.

Before driving, it must be ensured **that all** sash fasteners are in the closed position (Fig. 31).

Only with locking of **all** sash fasteners is it ensured that the hinged windows remain securely closed and that property damage and personal injury are prevented during driving.

Overview

5.1.5 Kitchen window



Fig. 32: Sliding window (optional)

Depending on the selected model and fittings, the kitchen area features a sliding window (optional) or a hinged window that must be opened during cooking to ventilate the interior.

Opening and closing the sliding window

- To open, press the inner slide handle to the side and hold; at the same time slide the moveable part of the window to the side.
- When closing, ensure that the slide handle again engages.

5.1.6 Combination blinds

Combination blind



Fig. 33: Combination blind

The hinged windows are fitted combination blinds consisting of a fly screen and a blackout blind. Both blind components are hung from the window top.

For both blinds:

- To close, use the handle to pull the fly screen fully downward and slightly push against the window until the lower strip latches.
- To open, push the handle downward and slightly pull toward yourself until the lower strip detaches. Due to the tension, the blind automatically rolls up – hold the handle during this action.

The blackout blind can be lowered in three different heights. It latches in one of three possible positions in the lateral guide rails.

ATTENTION



Damage to the blinds if they fly up!

To avoid damage to the blind, ensure that the blind CANNOT fly up.

NOTE



Do not keep the blind closed during driving and over a longer period of time (several weeks).

Over time, the springs would suffer if the blinds are permanently lowered.

Re-tensioning the blinds

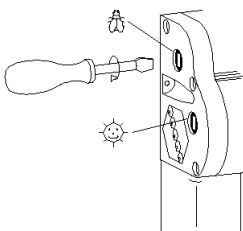

Blind care

Use a screwdriver to re-tension the blind springs.

- Insert the screwdriver and turn once or twice clockwise.
- Check the tension and repeat the process, if required. Ensure that you don't over-tension the springs.

As a rule, never use aggressive cleaning agents (solvents or abrasives). Use a damp cloth and soapy water to clean the blinds and frame parts. Use a soft brush and/or damp cloth to clean the fly screen.

Overview

5.1.7 Air conditioning system (optional)



Fig. 34: Air conditioning system (optional)

As a special option, a special attachment air conditioner is available to regulate the room temperature of the interior.

In summer operation the air conditioner generates dehumidified cool air. In winter operation it generates supplemental warm air, without, however, replacing the heater of the vehicle.

The air conditioner is installed in the vehicle roof.

Operation, maintenance, and service of the air conditioner are described in detail in the corresponding operating manual.

NOTE



Retrofitting of an air conditioning system is not possible due to the lack of roof reinforcement!

5.1.8 Skylights

Different models of skylights are installed in the ceiling depending on the model and selected equipment. The skylights are opened and locked from inside.

The skylights have fly screens, blackout blinds, and forced ventilation slots.

Depending on the model, skylights can be opened upwards or placed in a diagonal open position.

ATTENTION



Material damage due to open windows or skylights when driving!

Open windows or skylights can hit signs, light poles, and other elements and cause severe damage to the vehicle and other property.

- Never drive with opened windows or roof canopies!
-

Models

Model variants



Fig. 35: Skylight (Heki 2)



*Fig. 36: Skylight 400x400 mm
VisionStar 700x500 mm*



Fig. 37: Prop-up skylight



Fig. 38: Midi Heki / Mini Heki plus

Overview**5.1.9 Pop-up roof (optional)****Safety instructions****DANGER****Life-threatening danger due to lightning!**

During a thunderstorm, any persons in the pop-up roof can suffer life-threatening injury.

- Never stay in the pop-up roof during thunderstorms.

WARNING**Danger of injury due to falling!**

When sleeping, playing, or if they are in the pop-up roof unattended, small children can fall through the passage and suffer broken limbs and permanent bodily injury.

Persons with limited mobility can fall when climbing up and climbing down or can injure themselves in the hinged pop-up roof.

- The pop-up roof is not suited for unsupervised use by children under six years.
- Persons with limited mobility should avoid using the pop-up roof.

CAUTION**Health damages due to exhaust gases!**

In adverse wind conditions, the heating system's exhaust gases may be drawn into the sleeping area.

- Close all tent windows when operating the heater.

ATTENTION**Risk of fire due to the ceiling light**

The ceiling light may scorch the interior furnishings.

- Turn off ceiling light after every use.



Fig. 39: Pop-up roof, opened



Fig. 40: Pop-up roof, interior



Fig. 41: Vent window



Fig. 42: Passage

Upon request, a pop-up roof manufactured from fibre-glass reinforced plastics (GFRP) can be installed in the roof. In pop-up status, it offers two additional sleeping berths.

The pop-up roof features a large bed pad with slatted frame, a skylight, a fly-screened ventilation window with protective rain cover (lockable from the inside), two transparent sheet windows with black-out blind, one supplemental vent with closing mechanism, and a ceiling light with remote control.

ATTENTION



Material damage due to raised pop-up roof when driving!

An open or unsecured pop-up roof can get caught on trees, signs, light poles, in entrances to parking garages, or other parts, it can tear off and cause severe damage to the vehicle and property owned by others.

- Never drive with opened or unsecured pop-up roof!
- Prior to driving, always check that the pop-up roof is properly folded and secured and latched against unintentional opening!

The pop-up roof can be easily opened by simply pushing the rod at the rope against the GFRP shell. It is then held in position by pneumatic springs. It can be quickly closed by pulling it down.

- Do not use the pull rope as a climbing or holding rope!

NOTE



Due pressure differences, the pneumatic springs may act with different force at different ambient temperatures.

Overview

Care tips

NOTE



Thoroughly vent the roof bellows several times during the season, to prevent stagnant moisture and musty smells.

Do not fold the pop-up roof in damp or wet condition immediately after rainfall, for example.

Prior to longer periods between use, remove the bed pad from the pop-up roof to avoid stagnant moisture and mildew.

Also observe the care tips in section 7.3 on page 170!

5.1.10 Awning fastening



Fig. 43: Awning fastening

On the entry side of the caravan, on the outer edge, there is a circumferential profile strip (1) for fastening an awning.

The profile strip is widened somewhat on the rear of the vehicle.

- Start drawing the awning into the profile at this point.

5.1.11 Multifunction light switch



Fig. 44: Multifunction switch (example)

One or two switches are installed at convenient height in the entrance area. They control the various sources of light from inside and outside of the vehicle, permitting lighting the interior before entering the vehicle body.

5.1.12 Exhibition lighting system

The caravan is equipped with the light function referred to as "Exhibition lighting".

By pressing the button for the awning lighting 5 times in the entrance area, the exhibition lighting system is activated. This means that the base light (awning light, ceiling light, kitchen light, bathroom light) and the indirect lighting will automatically switch on again no later than 30 seconds after it has been switched off.

If it has been activated accidentally, it can be cancelled by pressing the awning lighting button 5 times again.

Overview

5.1.13 LED switches and LED displays

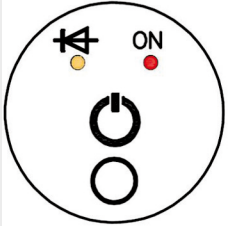
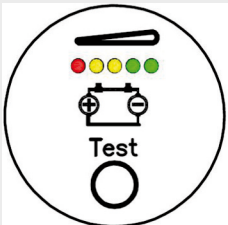

Fig. 45: Function switch (example)

The LED switches and LED displays for the various 12V/230V consumers are arranged above the entrance. The number of switches and displays fitted in the control panel varies dependent on the specification.

A summary of all the various switches and displays with LEDs and their meaning is given in the table.

Figure	Description	Display
	Truma Therme switch	On/Off switch: ■ red = on
	Display for fresh water level	■ red = empty tank ■ yellow = half-full/half-empty ■ green = full tank
	Display for grey water level	■ green = empty tank ■ yellow = half-full/half-empty ■ red = full tank
	EisEx remote display	■ yellow = switched on ■ green = gas consumption from the active bottle ■ red = gas consumption from the reserve bottle

Figure	Description	Display
	Switch for floor heating	On/Off switch: ■ red = on
	Charger switch for stand-alone package	Left LED – charging status: ■ red = main charging phase ■ yellow = full charge phase ■ green = charge maintenance phase Right LED – On/Off switch: ■ green = on
	Battery charge status display	■ red = empty battery ■ yellow = half-full/half-empty ■ green = full battery

5.1.14 Smoke alarm



Fig. 46: Smoke detector

A battery-operated smoke alarm is attached to the ceiling of the living area. If smoke develops in the vehicle, an acoustic alarm sounds warning the passengers of a possible fire.

The smoke alarm's integrated power supply via the installed 9V block battery ensures that the smoke alarm functions independently of the vehicle electrical system, and that it also operates when the vehicle's power supply is switched off.

- Prior to using the vehicle for the first time, remove the protective foil from the block battery to activate the smoke alarm.
- Regularly check the block battery and replace when necessary.

Overview

5.2 Furnishings

5.2.1 Sitting area



Fig. 47: Sitting area, example

The shape and arrangement of the sitting area and table installed in the caravan depend on the model. Lower the table top to provide additional sleeping spaces (→Section "Sitting and sleeping").

NOTE



Fading of the upholstery can be effectively countered by always protecting the sitting area from direct sunlight.

5.2.2 Bathroom

NOTE



Waste water, solid waste and chemical substances can cause significant environmental damage.

- *Drain the waste water and solid waste tank only at designated disposal points.*



Fig. 48: Bathroom, example

Depending on the model and selected equipment, the bathroom is fitted with a washbasin and under-sink cabinet, shower stall, toilet, and either a skylight with fly screen and forced ventilation, or a side window.

Hot water is supplied via the mixer tap.

The waste water runs to the outside via the drain or into the waste water tank (optional), if ordered with configuration.

A large mirror is installed above the washbasin.

Shower stall



Fig. 49: Shower stall, example

Depending on the floor plan and selected equipment, the bathroom contains a shower. It is surrounded by a shower curtain or a shower door that keeps water inside the shower.

ATTENTION



Material damage if the splash protection door is not locked in place when the vehicle is in motion!

If the splash protection door is not locked in place when the vehicle is in motion, it may swing open and destroy the bathroom fixtures.

- Prior to starting any trip and, ideally, immediately after each use, always secure the splash protection door with the provided fasteners!

The shower is supplied from the hot water boiler and features a mixer tap, storage shelf and towel holder.

Removable slatted floor (optional)



Fig. 50: Removable slatted floor

This visually appealing wooden floor insert protects the surface of the shower tray.

However, the insert can suffer from excessive moisture during showering and accumulate mildew. Remove the insert during showering or ensure the wood is oiled regularly (at least every six months) using linseed oil.

Linseed oil and similar products are available from specialist shops or DIY stores.

Overview

Toilet



Fig. 51: Toilet, example permanently installed

The cassette toilet is installed next to the washbasin or the shower.

Depending on the caravan's floor plan, the cassette toilet is either permanently installed or it rotates supported on bearings.

For some floor plan models, a separate flushing water tank for permanently installed toilets is provided.



Fig. 52: Holding tank with flushing water intake port

The waste water from the toilet is collected in the holding tank.

- To empty and clean, remove the holding tank from the outside via the sanitary compartment.

For permanently installed cassette toilets, the flushing water intake pipe is located here as well.

5.2.3 Kitchen area



Fig. 53: Kitchen area, example

The kitchen area is designed for longer stays. The kitchen counter area features a gas cooker, sink and a small working surface. The gas cooker and sink are covered with safety glass panels.

Cabinets for crockery are installed above this counter.

The window behind the hob ensures sufficient fresh air when preparing food.

Large kitchen items such as pots and pans have a secure place in the large drawers in the lower kitchen cabinet.

Depending on the vehicle's model, drawers or lattice-type trays provide quick access to the stored objects.

CAUTION



Risk of injury due to flying crockery and hot cooking appliances!

Flying dishes and hot cooking appliances can cause serious injury and material damage.

Before each journey:

- Turn off the gas cooker and shut off the gas supply.
- Safely store crockery and kitchen appliances.
- Close the glass panels and kitchen window.
- Lock the cabinets and drawers.

Overview

Refrigerator



Fig. 54: Refrigerator (example)

The kitchen area includes the refrigerator, which, depending on the vehicle equipment, can be supplied with 12 V, 230 V, gas or a combination of different types of energy.

NOTE



Gas ignition at altitudes higher than 1000 m above sea level may be problematic - this is not a malfunction but a result of reduced atmospheric pressure.

The refrigerator works without any problem at inclines up to approximately 5°.

The refrigerator is designed to be flame-proof. The gas supply shuts off automatically if there is insufficient gas.

5.3 Storage compartments

5.3.1 Storage space in the floor area

WARNING



Danger of accident and injury due to unsecured packed goods!

Unsecured luggage and excessive load adversely affect driving behaviour; luggage can slide and cause serious accidents.

- Comply with the specifications for maximum permissible load.
- Weigh luggage before loading and distribute weight uniformly.
- Secure all luggage so that it cannot slip.

Under-bed storage



Fig. 55: Under-bed storage

Storage compartments under the beds are available for medium-sized luggage. Under-bed compartments can be reached via a hatch or by lifting and unfolding the slatted frame under the mattress.

Overview

5.3.2 Wall cupboards

Wall cupboards in the living area



Fig. 56: Wall cupboards in the living area

Additional storage possibilities are offered by the hinged compartments and open storage units e.g. above the sitting area as shown in the illustration.

This is a good place to store items of common interest, such as games, maps, or magazines.

Wall cupboards in the sleeping area



Fig. 57: Wall cupboards in the sleeping area

Hinged compartments are also installed above the beds; these compartments are primarily designed to hold useful accessories that are used daily such as towels and casual clothing.

Upper kitchen cabinet



Fig. 58: Upper kitchen cabinet, example

Small and medium-sized kitchen items such as crockery, plastic glasses, or cups are best stowed in the lockable storage units above the kitchen block.

Storage areas in the bathroom



Fig. 59: Cabinet compartments in the bathroom, example

Cosmetics, toilet and hygiene articles can be stored in the storage shelves, and upper and lower cabinets in the bathroom.

Additional storage space is provided by, for example, a mirror cabinet, if supplied with the model and selected equipment.

CAUTION



Damage due to unintended opening of the mirror cabinet doors during the trip!

Mirror cabinet doors can open on their own due to driving vibration and damage the fixtures in the bathroom.

- Prior to driving, lock the mirror cabinet door to prevent unintended opening of the doors.

Overview

5.3.3 TV bracket

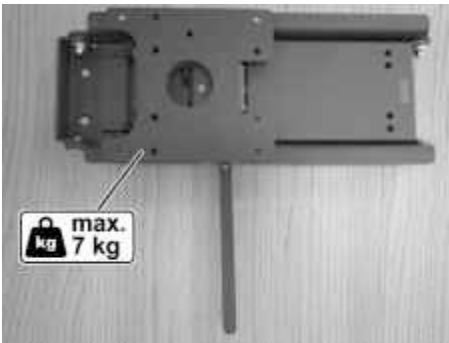

Fig. 60: TV wall mounting, example

A TV wall mounting is available for the safe carrying of a flat screen TV. The smooth-action lateral pull-out and the rotation function mean it is easy to move the TV into the desired position.

- Follow the manufacturer's instructions when mounting the TV on the retaining plate.
- The sprung steel lock must be moved left or right to unlock, depending on the seating. Simultaneously, pull the TV mounting unit to the desired length and, if necessary, adjust the angle of inclination.
- To lock the TV, position it vertically again. The TV must then be retracted as far as it will go until it clicks into place with an audible sound.

CAUTION



Damage to property due to falling TV!

While driving, the TV may fall down due to vibrations.

- Take down the TV before driving!
-

5.4 Technical equipment

General

Your caravan is equipped with modern and convenient technical systems. This section provides important information on the structure and function of the equipment and built-in devices.

5.4.1 Electrical system

General

The electrical system of the caravan is configured for 12 V and 230 V operation.

As soon as the 230V input of the caravan is connected to an external 230V supply network (e.g. via a camping site outlet), the dual devices are operated via the supplied power connection in conjunction with the power supply unit.

If the caravan is fitted with a stand-alone package (optional), a charger will charge the supply battery (optional). At full battery capacity, the charger ensures constant charge. In this case the 12V consumers (lighting, water pump, except for the refrigerator) are supplied with electricity from the supply battery.

When driving the rig, only some of the 12V consumers are supplied from the battery of the towing vehicle.

NOTICE



During interruptions in travel (e.g. rest breaks), always switch off the 12V consumers to prevent the rechargeable starter battery from discharging unnecessarily!

DANGER



Life-threatening danger due to electric shock!

Danger of electric shock potentially resulting in serious or fatal injury when working on electrical equipment.

- Any repair tasks on the electrical system must be performed by qualified personnel.
- Replace defective fuses only after the cause of the fault has been identified and rectified.

Overview

Power connection

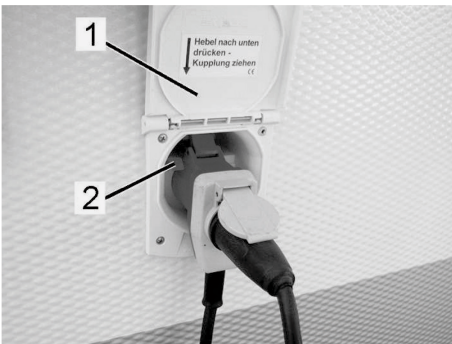

Fig. 61: Power connection

The power connection (Fig. 61) is located under a protective cover (1) at the outside of the caravan.

Connect the CEE cable with the connection plug and secure with the stopping lever.

NOTE



Before travelling to foreign countries, obtain information about the plug and connector systems used at your destination. Suitable adapters are commercially available.

Converter (power supply unit) and cut-outs

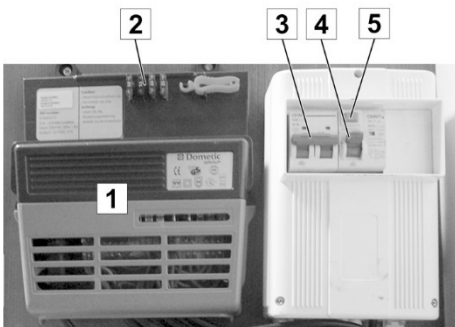

Fig. 62: Converter (power supply unit) (1) and cut-outs

The electric system is secured with a miniature circuit breaker and a residual current circuit breaker (RCD). The miniature circuit breaker also serves as the main switch. By contrast, in large caravans, e.g. tandem-axle configurations, a second converter can be deployed to handle the multiple 12 V consumers.

- 3 Light circuit
- 4 RCD
- 5 Test switch for RCD

The power supply is divided in separate circuits:

Power circuit	Assignment	Nominal current in [A]
Light circuit 1, (2) for 12 V	Interior lighting and 12 V power outlets	10
Light circuit 2 for 230 V	230 V power outlets (including optional ALDE)	16

- Reserve fuses (2) at the converter housing (1).
- Shut the circuit breaker off if the vehicle is not in use (e.g. during the winter months). This disconnects all devices from the power supply.

CAUTION



Material damage due to improper checks!

Check the RCD every six months by activating the RCD test switch.

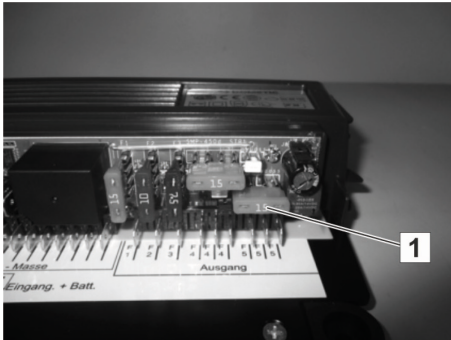

Fig. 63: 12 V-Emergency lighting



Fig. 64: 12 V-Complete supply

12 V Emergency lighting

If the 15 A plug-in fuse (1) is in its outer position, the power supply uses the standard setting with emergency lighting.

12 V Complete supply

If the blanking plug is removed and the 15 A plug-in fuse (1) is set to the left (3), the power supply uses the 12 V-complete supply setting.

The refrigerator is protected by the charge cable (pole 10). Hence, the refrigerator is supplied with 12 V from the generator only when the engine of the towing vehicle is running.

CAUTION



Material damage due to deep discharge!

The starter battery of the towing vehicle may fully discharge when the power supply uses the 12 V-Complete supply setting.

This deep discharge would be caused by the 12 V lighting and other 12 V consumers.

- Always switch off all 12 V consumers in the caravan when it is not in use to prevent a total discharge of the starter battery during standstill.

NOTE



In towing vehicles meeting the EURO 6 standard, it can happen that the on-board computer shuts down the power supply for the refrigerator due to excessive current consumption.

NOTE



Red LEDs are found next to the plug-in fuses. If an LED illuminates, it indicates that the corresponding fuse is defective.

Overview

5.4.1.1 Supply battery

General

You can use either a conventional lead/acid battery or a so-called AGM battery.

The supply battery supplies all activated 12-V consumers when the system is not connected to an external power source. While this is the case, the supply battery is continuously discharging.

To maintain long-term functional operating condition it requires basic maintenance. The charger has been equipped with a battery monitor protecting the supply battery from total discharge during use.

However, irreparable damage can occur if the vehicle is parked for longer periods (e.g. in winter) without manual maintenance. For this reason, you must use the charger to recharge the supply battery at least once a month.

For an unused but not fully discharged supply battery, the charging process will be completed after ten to twelve hours.

AGM battery (optional)

The AGM battery (**absorbent glass mat**) is a state-of-the-art battery that absorbs the electrolyte in a special fibre-glass matting. It does not have any free (liquid) sulphuric acid and can be operated in any position. The acid cannot escape even if the AGM battery breaks. AGM batteries are ideally suited for the use in mobile homes and caravans.

Benefits:

- Low maintenance (closed system)
- High cycle stability, long service life
- Good total discharge properties
- Low spontaneous discharge, long storage life
- Escape proof, no gas formation, no corrosion, no drip tray
- High shock and vibration resistance
- Small footprint at comparable capacity

It is recommended to charge the AGM battery in the early times once a month for more than 24 hours. At low discharge, this interval can be extended, depending on external temperatures, once per quarter for example.

CAUTION**Damage due to incorrect use!**

An auxiliary battery should only be replaced with one of the same type and specification as the one originally specified by the caravan manufacturer.

NOTE

Only batteries of the same type and same capacity can be connected in parallel.

Overview

Stand-alone package (optional)



Fig. 65: Battery cover with control module for mover (optional)

The stand-alone package comprises a supply battery and a charger located beneath the housing.

The supply battery supplies all 12 V consumers as soon as the 12 V main switch above the entrance door is switched on and the 12 V consumers are activated. Thus, the supply battery is continuously discharging.

Exception: 12 V operation of the refrigerator.

The refrigerator can be in 12 V mode during driving only via the charge cable. During standstill, you can operate the refrigerator only with gas or an external 230 V supply.

The charger recharges the supply battery as soon as you have connected to the 230 V power supply. The 12 V consumers are supplied only via the supply battery. As soon as the supply battery has reached its full capacity, the charger will provide sufficient trickle charge.

Comply with the safety instructions and operating instructions provided in the manufacturer's documentation for operation!

CAUTION



Fire danger due to heat accumulation!

Supply battery and charger become hot during operation and can cause smouldering or fire if heat cannot be discharged properly.

- Never cover the supply battery and the charger.
 - Do not misuse the storage space of the supply battery and the charger as the storage space for other objects.
-

NOTE

- *The charger must only be installed and opened by authorised specialist personnel!*
- *The device must be fully disconnected from the power source before the fuses are replaced!*
- *Fuses must be replaced with fuses of the same fuse class and category!*
- *Prior to replacing a defective fuse, the cause of the fuse having tripped must be eliminated (short-circuit, overload)!*
- *Incorrect polarity of the connected battery or the input voltage can result in a defective control unit.*
- *Insufficient ventilation of the device causes a reduction in the charge current.*
- *The housing surface can become hot during operation!*

Charge status**CAUTION****Explosion hazard due to overcharging!**

A defective charger can cause "boiling" of the supply battery and an explosion.

- Switch off the charger immediately if the battery is boiling.
- Have the defective charger repaired by an authorised specialist workshop or replace with a new unit.

Overview

ATTENTION**Material damage due to improper maintenance!**

Improper maintenance of the battery will cause destruction and total failure of the unit!

- Comply with manufacturer instructions.
- Travel only with fully charged battery.
- After every trip, recharge the battery for 12 hours.
- Batteries subject to high ambient temperatures ($\geq 30\text{ }^{\circ}\text{C}$) require more frequent recharging.
- At shut-down times of more than four weeks, disconnect the batteries from the on-board system and recharge on a monthly basis.
- Check the acid condition at least once a year (only in lead-acid battery).

WARNING**Risk of injury due to improper handling of batteries!**

Batteries can release toxic acid, explode and cause severe injury if handled improperly.

- Do not expose batteries to high temperatures. Do not place in the vicinity of sparks, ignition sources, or naked flames. Do not smoke.
 - Do not unclamp the terminals during charging nor move the batteries.
 - Do not touch escaping fluids. In the event of skin contact, wash immediately and thoroughly with water.
 - Eye contact: Rinse out eyes immediately with plenty of water and seek medical attention.
 - Collect escaped fluid with suitable absorbent cloth and dispose of according to applicable environmental regulations. Wear protective gloves!
-

5.4.1.2 Interior lighting

LED spotlight



In the interior, above the bench and in the sleeping area, there is a track light system with 12 V LED spotlights. Those can be rotated, pivoted and adjusted, allowing all areas to be well illuminated (for use see → "Arranging the lights" section).

Each spotlight has its own ON/OFF switch.

The lighting fixtures are switched via power circuits 1 and 2. If the power circuits are disconnected, the spotlights cannot be used.



Fig. 66: LED spotlight

Overview

Room spotlights



Fig. 67: Canopy

Depending on the model and the selected equipment, there are either room spotlights with multiple rotating and pivoting LED lamps on a rail system, or permanently installed lights in the canopy. These are activated via a central ON/OFF switch. The light intensity can be regulated.

Bathroom lighting



Fig. 68: Bathroom lighting, example

In the illustration on the left-hand side, the LED lights are installed in the bathroom above the mirror of the washbasin. These lights are also switched via lighting circuits 1 or 2. They can be operated if the lighting circuits are enabled.

Kitchen light



Fig. 69: LED light rail (typical)

There is an LED light rail in the kitchen area below the top cabinet, which can be switched on and off via an ON/OFF switch.

Canopy light (optional)



Fig. 70: Canopy light with LEDs

The awning light (optional) lights up the entrance area at night. It can be operated with the remote control unit (optional) or the corresponding button on the entry door.

The awning light must always be operated manually. For safety reasons, it does not switch off automatically and remains in operation until it is switched off.

NOTE



The canopy light is not a headlight authorised for traffic and must be switched off before driving!

Remote control unit (optional)

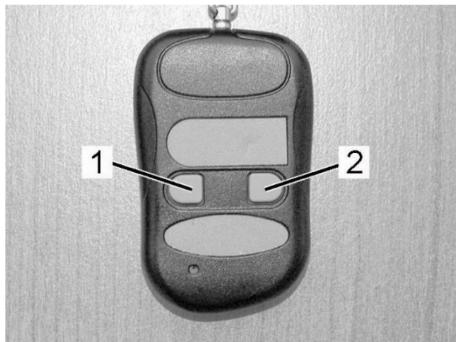

Fig. 71: Remote control

Use the remote control to operate the awning light and the ceiling light.

The buttons on the remote control unit have the following functions:

- 1 Awning light ON/OFF
- 2 Ceiling light ON/OFF

The light intensity can be regulated by keeping the ceiling light switch depressed.

Overview

5.4.1.3 Power outlets

230V outlet



Outlets for the connection of small appliances when an external power supply is connected can be found at various locations in the vehicle interior, depending on the model and selected equipment (the picture shows an outlet in the support of the sitting area).

Fig. 72: 230 V outlet, example

12 V socket (optional)



If a TV wall mounting is fitted, a 12 V socket will also be installed for powering the TV from alternate voltages.

Fig. 73: 12 V socket, example

USB socket (optional)



Depending on the vehicle's equipment level, a USB socket will also be available in the vehicle.

Fig. 74: USB socket, example

5.4.1.4 System Information Unit (SIU) (optional)

The app must be downloaded before the service functions of the app-controlled service unit can be used.

To do so, please scan the QR code on the inside of the wardrobe door and then follow the further instructions.

As a precaution, a second QR code is located directly on the control unit in the front of the storage compartment.

After downloading the app, two basic functions are available.

- Voltage display
- Levelling aid for assistance in levelling the caravan

The SIU has a range of 10 m.

Dependent on the extent of the optional equipment purchased, other functions may be available.

5.4.2 Gas supply

General

This section provides information about the gas supply system in the caravan.

The installed gas appliances (depending on the selected equipment: heater, boiler, hob, oven, grill, refrigerator) - are explained in detail in the accompanying operating manuals provided by the respective manufacturers.

WARNING



Danger of explosion and injury due to gas!

Escaping gas can cause poisoning and explosions.

- All repairs on the gas system must be performed only by authorised specialist personnel.
- If gas odour is detected:
 - Immediately shut down the gas supply.
 - Do not operate any electric devices.
 - Remove fire and sources of ignitions.
 - Do not smoke.
 - Have gas system repaired immediately.

Overview

Gas cylinder box, EXQUISIT VIP



Fig. 75: Gas bottle locker lock



Fig. 76: Gas bottle locker lid, open

The gas bottle locker is located in the front above the draw-bar. The gas bottle holder and the gas pressure regulator are located here.

NOTE



Depending on the selected equipment, a gas pressure regulator set (optional) with automatic switch-over function can be pre-mounted.

- The lock for the gas bottle locker enclosure is located behind the cover.

Open lid:

- Raise cover.
- After opening the lock, the knob springs out.
- Turn the knob to the right to unlock the gas bottle lid.
- Reach into the recessed grip and press gas bottle locker lid upwards.

Close lid:

- Press the gas bottle locker lid down.
- To lock the gas bottle locker lid, press down and lock with the button.

This is particularly useful if a bike holder is mounted on the draw-bar and bicycles are attached to the bike holder. In this case, you don't need to remove the bicycles in order to close the gas bottle valve when refuelling or after cooking, for example.

Gas supply with low pressure regulator and low pressure hose



Fig. 77: Gas bottle with low pressure regulator and low pressure hose

For connection of a gas bottle, a flexible gas hose with pressure reducing valve is installed. The pressure reducing valve is fitted with a sleeve nut with left-hand thread, and should only be screwed hand-tight with the gas bottle. Gas hose and pressure reducer must be examined for leaks at each gas test, and replaced if the status is deficient, at the latest, however, the gas hose and pressure reducer must be replaced at the end of the permissible service life.

- Place the gas bottle in the gas locker and lash the bottle tight with the securing belt.
- Screw the pressure reducing valve directly onto the thread of the discharge valve on the gas bottle and hand tighten.

Gas supply with the DuoControl CS



Fig. 78: Gas supply (with Eis-Ex and remote control)

A safety regulating system for gas pressure with integrated crash sensor is available at a surcharge for a two-bottle gas supply. It enables switching the gas bottle without interrupting the gas supply.

The regulating system for the gas pressure comprises an automatic switch-over valve (DuoControl), the gas pressure regulator, the regulator heating element (Eis-Ex), and a remote control displaying the status of the bottle in operation.

The regulating system for the gas pressure is mounted at the wall of the gas bottle locker and connected to the gas bottles via two high-pressure hoses. The regulating devices and hoses must be replaced at the latest ten years after the manufacturing date.

The high pressure hoses are equipped with a left-hand thread cap nut. During every gas test, the high-pressure hoses must be tested for tightness and replaced if necessary.

- Place the gas bottles in the gas bottle lockers and lash tight with the securing belt.

NOTE



During an accident with a delay of $3.5 \text{ g} \pm 0.5 \text{ g}$ directly affecting the trigger element (corresponding to an impact speed of 15 – 20 km/h to a solid obstacle at a mean vehicle weight), the integrated crash sensor will interrupt the gas flow.

Eis-Ex (optional)

Ice or propane hydrate formation on the regulator can hinder or stop the gas supply in winter.

The regulator heater prevents formation of an ice plug through electric heating. Thus, trouble-free gas supply is also ensured in winter conditions.

Overview

Remote display (optional)

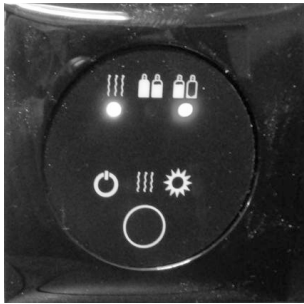

Fig. 79: Remote display

The remote display (optional) shows the gas consumption status in the vehicle interior (normal or reserve operation), as well as the heating operation of the regulator heater:

After switching on, the display LEDs mean:

- Green LED = Gas consumption from the active bottle
- Red LED = Gas consumption from the reserve bottle
- Yellow LED = Regulator heater active

Quick-closing valves



Fig. 80: Quick-closing valves

The quick-action valves for the gas appliances are located in the caravan body, either in the drawer under the counter-top (as shown in the Fig.) or in the lower cabinet in the kitchen. The quick-closing valves must be accessible at all times.

Each gas appliance has its own quick-action valve.

The arrow on the quick-action valve indicates whether gas flow to the gas appliance is open or shut off.

The quick-action valves are marked as follows:

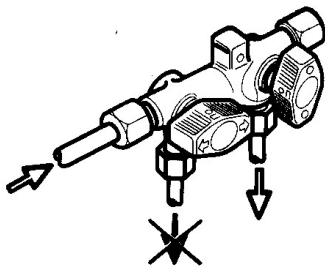

Fig. 81: Shut-off and release position

Symbol	Meaning	Symbol	Meaning
	Hob		Hot water boiler
	Oven		Heater
	Refrigerator		Combination device hot-water boiler with heating system

- Always close the quick-action valves prior to fuelling, and after using the gas appliance!

5.4.3 Heater

General

With the heating systems hot air heating and hot water heating are completely differentiated.

With the Truma combination heater, the boiler is integrated for the first time, although it is hot air heating that is involved, so that a compact hot air heater (Truma-Combi) or a compact hot water heater (ALDE) are available alongside conventional hot air heating.

5.4.3.1 TRUMA heater 3004 S and 5004 S

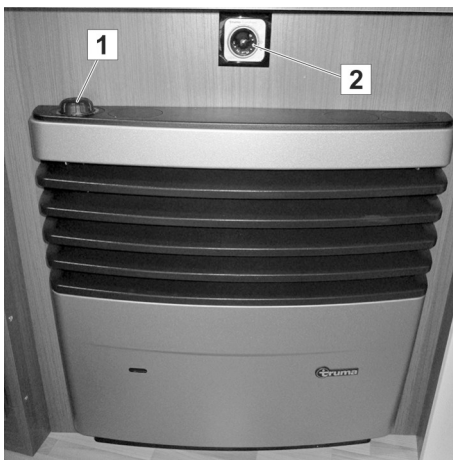

Fig. 82: TRUMA heater

The vehicle is always equipped with a gas heating system. It is operated via the thermostat (1).

The gas heater generates hot air that is distributed in the caravan body via a hot-air pipe system. The hot-air blower is operated with the operating switch (2) directly mounted above the heater.

The hot air blower will work only when an external 230V power supply is connected.

NOTE



In many countries, the operation of gas heaters during driving is not allowed. Before starting the trip, obtain information about the locally applicable regulations on the transit route and at the destination. If in doubt, close the gas heater prior to starting the trip, as well as the quick closing valve and gas bottle valve.

Overview

Hot-air nozzle



Fig. 83: Hot-air nozzle, open

To heat the caravan body, the blower drives hot air through the hot-air piping and expels the air through the hot-air nozzles into the caravan interior.

To regulate the flow of hot air as needed, the hot-air nozzles installed at various points can be manually opened or closed.

- To open and close bring the revolving dampers of the hot-air nozzles into the desired position.

Exhaust gas stack



Fig. 84: Exhaust gas stack of the gas heater

The exhaust gas stack to discharge burnt heating gas is installed in the caravan's roof.

The opening must always be free and clean to ensure unobstructed discharge of the exhaust gases.

NOTE



Always keep the opening free of leaves, dirt, and other fouling!

5.4.3.2 ALDE- heater (optional)

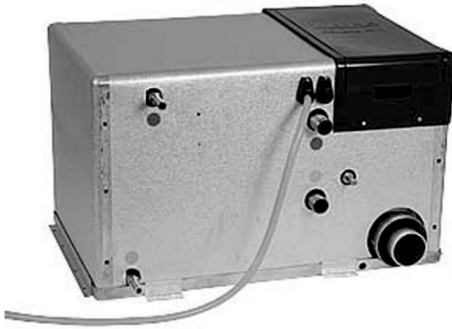

Fig. 85: ALDE heater

The ALDE heater (optional) with hot-water heater is a classic heating system similar to systems used in many households.

It comprises a boiler operated with standard camping gas cartridges heating a glycol-water mixture and conveying the same into a closed circuit with convector elements (heating elements), recirculating pump and expansion vessel.

The ALDE system additionally features a 230 V electric heater for fast heating of the parked vehicle, if required.

NOTE



In many countries, the operation of gas heaters during driving is not allowed. Before starting the trip, obtain information about the locally applicable regulations on the transit route and at the destination. If in doubt, close the gas heater prior to starting the trip, as well as the quick closing valve and gas bottle valve.

NOTE



Appropriate maintenance is important to protect the ALDE heater from damage.

- *Replace the glycol/water mixture every two years to prevent rust in the heating system.*
- *Vent the system if the convector elements in the vehicle heat up unevenly.
First vent the heating system in cold state. If the result is unsatisfactory, vent the heating system in warm state.*

See chapter "Maintenance", section "ALDE heating maintenance overview" for a table to record the maintenance tasks performed.

Overview

ALDE control unit

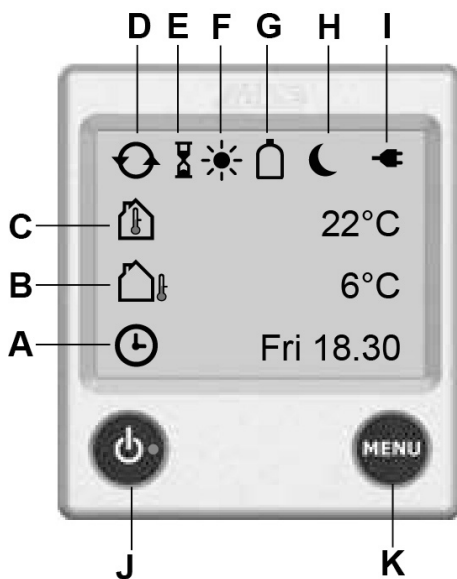

Fig. 86: Controls

- A Clock.** The clock displays date and time (if activated). For its setting, please see the ALDE operating manual.
- B Outside temperature*.** The outside temperature is displayed.
- C Inside temperature.** The inside temperature is displayed.
- D Recirculating pump.** This symbol is displayed when the recirculating pump is operating.
- E Automatic start of the heater.** This symbol is displayed when the function has been activated.
- F Day automatic.** This symbol is displayed when the function has been activated and the time is within the set period.
- G Liquefied gas bottle full/empty*.** This symbol is displayed when the sensor at the gas regulator is connected to the bottle and activated. If "Eis-Ex" is installed, the symbols for the set mode is shown with the bottle symbol.
- H Night automatic.** This symbol is displayed when the function has been activated and the time is within the set period.
- I 230 Volt.** This symbol is displayed when 230 V voltage is applied to the heater.
- J On/Off button.** Main switch for the heater.
- K MENU button.** Button to open the Settings menu.

The functions identified with (*) are optional equipment.

Wall exhaust stack



Fig. 87: Wall exhaust stack

The wall exhaust stack channels the camping gas that is burned in the gas heater to the outside. Depending on model and selected equipment, it is located on the left side of the vehicle.

The opening must always be free and clean to ensure unobstructed discharge of the exhaust gases.

NOTE



Never use the cover as a clothes hook or to fasten objects!

Always keep the opening free of leaves, dirt, and other fouling!

Window switch



Fig. 88: Window switch

If the exhaust gas stack is installed below a window, the window switch is installed at the corresponding window.

The window switch is a contact switch that automatically shuts down the heater when this window is opened so that no exhaust gases enter the vehicle interior.

ALDE convector (optional)



Fig. 89: Convector with thermally conductive panel

Heat is dissipated in the interior of the vehicle without blower support on the convectors.

To achieve fast warming, the hot-air must be able to circulate freely. Never cover convectors as it would obstruct circulation.

You can fill the heating circuit with the glycol/water mixture (ratio 40:60) at the expansion vessel. A venting valve is installed at all convectors for ventilation purposes.

- Comply with the safety and operating instructions in the operating manual provided by the manufacturer!

Overview

5.4.3.3 Heat the floor with hot water (optional)

A pipe system laid out under the floor with thermally conductive layers arranged on top serves as the floor heating system (optional). A special heating fluid (glycol/water mixture) circulates through the pipe system.

- In combination with the TRUMA Combi heater, the heating fluid is heated in a separate thermal unit. Here, the hot air generated in the gas heater is channelled through the thermal unit. To accelerate the heating process, the 230 V heating element integrated in the thermal unit can be switched on.
- In combination with the ALDE heater, the floor heating system represents an additional heating element in the heating circuit.

CAUTION



Danger of damage to the pipes in the floor!

Screws, nails, and other fastening material can damage the pipes in the floor and cause the heating fluid to escape.

- Do not retrofit, convert, or add individual installations in the living area.
- Never use screws, nails or other fasteners in the floor.
- Do not damage the floor surface.

NOTE



All claims are excluded for damage to the pipe system, consequential damage to the caravan body or fixtures and fittings due to installations in the floor

Function switch of the floor heater system

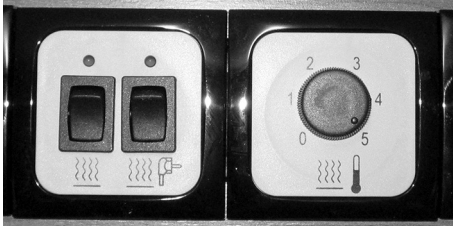

Fig. 90: Function switch (example)

In combination with the TRUMA Combi heater, the function switches for floor heating are located above the entrance door.



Fig. 91: ALDE floor heating valve

In combination with the ALDE hot water heater, the floor heating circuit can be switched on via a valve.

The valve is located near the ground directly next to the ALDE heater.

5.4.3.4 Heating the floor electrically (optional)



Fig. 92: On-Off switch of the floor heating system

The electric floor heating system (optional) is activated with the On-Off switch (1). It is located above the entrance door. The corresponding transformer is fitted in the bed frame or in the bench.

The floor heating system does not require maintenance.

WARNING



Risk of fire hazard due to damaged heating foil!

The heating foil is laid directly under the PVC carpet. There is a risk of fire if it is damaged.



- Therefore, for retrospective assembly or changes to the furniture layout, always have these modifications cleared in advance by your dealer.

Overview

5.4.4 Fresh water and waste water system

General

The following section provides information on the fixtures for fresh water supply and waste water disposal.

Fresh water intake port



Fig. 93: Fresh water intake port

The fresh water fill pipe connection is outside on the side wall of the caravan.

- To fill the fresh water tank, swing the hinged hatch cover upward. Insert the caravan body key in the lock and turn it by 180°. Then press the rotary cap closure, turn it 120° counter-clockwise and remove from the intake port.
- After filling, replace the rotary closure cap and lock it with the key.

NOTE



Standing water in the fresh water tank or in the water lines becomes unusable even after a short period. Thoroughly purge and rinse with fresh water before using the tank or water pipes after shut-down times. Special cleaning and sterilising agents are commercially available for regular use.

Fresh water tank (optional)

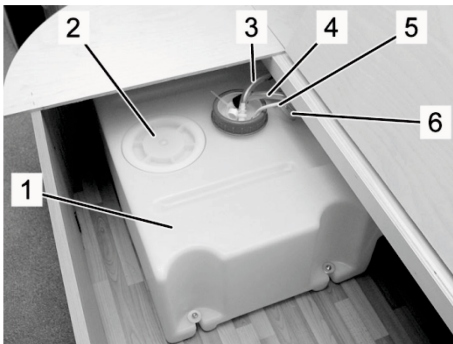

The fresh water tank is located in the living or sleeping area (shown in the Fig. under the bench seat of the sitting group as an example).

- 1 Fresh water tank
- 2 Cleaning cover
- 3 Ventilation for fresh water tank
- 4 Suction hose for the water pump
- 5 Supply line to the level indicator
- 6 Fill hose

Fig. 94: Fresh water tank, example

Second drain valve on the freshwater tank



The second drain valve is mounted to the side on the tank and can be operated using a knurled thumb screw. It is used for simple regulation of the freshwater filling level. Opening the second drain valve reduces the filling volume of the freshwater tank. This process means the caravan loading can be increased.

When arriving at the destination, the knurled thumb screw can be closed again to utilize the entire tank volume and to fill with fresh water.

- To open the second drain valve, turn the knurled thumb screw anticlockwise
- To close the second drain valve, turn the knurled thumb screw clockwise

Fig. 95: Drain valve, example

Overview

Mixer tap



Fig. 96: Mixer tap

WARNING



Danger of scalding due to hot water!

Hot water can scald hands and other body parts.

- Open the mixer tap in cold-water position and carefully raise the temperature.

1. To obtain water, turn the lever in direction of the cold-water setting (blue mark), lift upward, and slowly shift in direction of the red mark.
2. To close, turn the mixer lever in direction of the blue mark and push downward.

Drain plug in the fresh water tank



Fig. 97: Drain plug in the fresh water tank

The drain plug is integrated in the tank bottom and can be accessed after the service cover has been removed.

Waste water

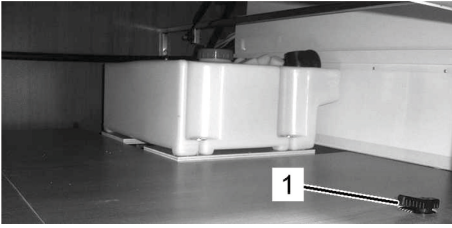

Fig. 98: Waste water tank (optional)

The waste water from sink and washbasin drains into a shared waste water conduit.

Depending on the model and selected equipment, the waste water is either captured in a permanently installed waste water tank (optional), or discharged into the exterior.

In a permanently installed waste water tank (optional), the drain valve (1) is installed in the immediate vicinity of the tank for easy access.

NOTE



Cleaning agents, soaps, wash lotions and cosmetics contaminate the environment and ground water.

- *Never drain waste water in free nature, dispose only at the designated disposal points!*

Overview

5.4.5 Water heater

ATTENTION



Damages after extended stand time or frost!

If the vehicle is not used in winter, the sanitary system may be damaged due to frost.

Extended stand times can cause algae growth in the sanitary system.

- Ensure that the overflow valve is free from contamination and ice formation.
- In the event of frost or extended stand time, completely empty the water tanks, containers, hoses, and conduits. Dry-run the pump for approximately five minutes to avoid frost damage caused by residual water in the pump.

NOTE



Frost damage or contamination caused by algae growth in the water system are not covered by the guarantee!

5.4.5.1 TRUMA heater and TRUMA water heater system

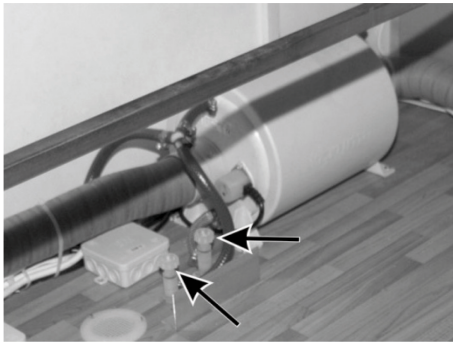

Fig. 99: TRUMA water heating and water drain valves

The TRUMA water heater is installed in the storage compartment under the bed.

This hot water heater heats the water in three ways:

- When the gas heater is activated, a portion of the heated air flows through the hot water heater via the hot-air piping where it heats the fresh water.
- Fresh water can be heated with the integrated electric heating system when the gas heater is switched off.
- Combination mode: Accelerated heating of fresh water via hot air from the gas heater and internal electric heater

To empty the cold and/or hot water circuits, manually-activated drain valves are located directly next to the hot water heater. (→ arrows).

NOTE



For servicing and care instructions for the water heating units, please refer to the enclosed unit operating instructions.

5.4.5.2 With installed ALDE heater (optional)



Fig. 100: Drain valves opened

The ALDE heater is fitted with a boiler (8.5 litre volume approximately). This boiler can be operated with liquefied gas or electric power. To fill the boiler, open the mixer tap for hot water.

In general, the heating system can be operated with an empty boiler as well.

When the vehicle is not in use, always drain the water system by opening the draining valves for hot and cold water (vertical lever position). They are installed directly next to the heater.

Camping

6 Camping

This section describes the operation and function of the equipment of your caravan. See also the instructions provided in the "Overview" section and those in the operating manuals for the built-in devices.

6.1 Setting up the caravan

6.1.1 Establishing the power connection

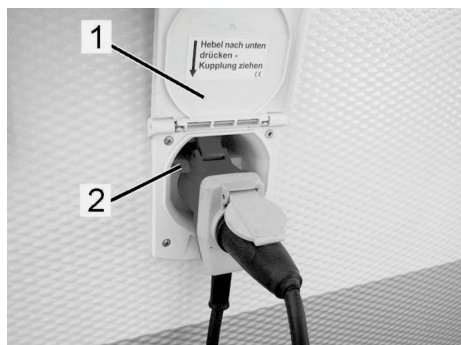

Fig. 101: Power connection

1. Before connecting, check whether the electrical supply mains matches the power specification of the caravan.
2. When using cable drums, completely unroll the power cable to prevent the cable from overheating.
3. Lay the cable so that it does not cause a stumbling hazard; mark the cable routing, if necessary.
4. Lift up the hinged cover (1) of the power supply connection on the side of the vehicle.
5. Push the stopping lever (2) upward and insert the CEE mains plug.
6. Connect the plug connector of the power cable to the external supply station.
7. Switch the refrigerator to mains or gas operation (→ section "Camping").
8. Turn on the main switch.

6.1.2 Filling the fresh water tank

WARNING



Health hazard due to germs and bacteria in the drinking water!

Contaminated drinking water can cause serious infections.

- Prior to the first use, disinfect the fresh water system of the vehicle, and thoroughly flush with drinking water.
- Transfer water only from supply systems with proven drinking water quality.
- Filling hose and container must be approved for drinking water.



Fig. 102: Fresh water intake port

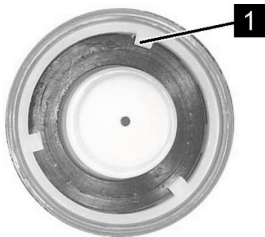

Fig. 103: Rotary cap closure, inside

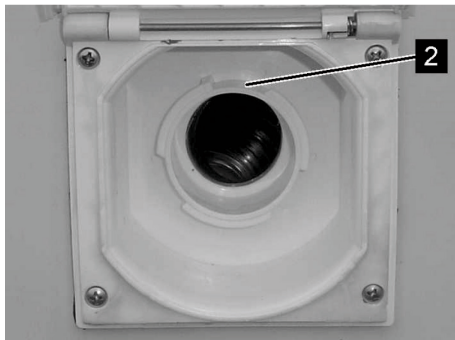

Fig. 104: Fresh water intake port, open

1. Drain any residual water out of the fresh water tank (→ section "Draining fresh water").
2. Open the fresh water intake port at the vehicle side.
 - Hold the twist cap firmly with one hand, insert the caravan body key into the lock and turn the key 180°.
 - When the lock is unlocked, press the twist cap and turn it 120° anticlockwise.
 - Subsequently, remove the twist cap.
3. Thoroughly flush the filling hose (allow at least two litres of fresh water to flow through the hose). Insert the filling hose into the intake port and fill with fresh water.
4. After filling, pull out the filling hose, replace the rotary cap closure of the intake port, and lock it.
 - Insert the rotary cap closure with the pins (Fig. 103/1) in the grooves (Fig. 104/2) of the fresh water intake port.
 - Press the twist cap and turn it clockwise 120°.
 - Turn the key in the lock 180° clockwise and withdraw the key.
5. Empty the filling hose and cap the hose ends.
6. Thoroughly flush out all water lines. Open the drain valves and flush out the lines. Then re-close the drain valves.
7. Turn on the water pump, open the mixer taps to mid position and flush out the lines. Then re-close the mixer taps.

Camping

6.1.3 Draining fresh water



Fig. 105: Drain plug in the fresh water tank

1. Open the drain valves for cold and hot water.
2. Open the mixer taps of sink and washbasin.
3. Open the service cover at the fresh water tank.
4. Remove the drain plug. Completely drain the water from the fresh water tank.
5. Check whether the fresh water system is completely empty. The water removal points (mixer taps, drain valves, discharge opening on the fresh water tank) must be dry.
6. Replace the drain plug in the fresh water tank and close the service cover.
7. Close the mixer taps of sink and washbasin.
8. Close the drain valves for cold and hot water.

TRUMA drain valves



Fig. 106: TRUMA combination heater drain valves

There are two drain valves in the lower cabinet:

- 1 Safety drain valve (cold water)
- 2 Manual drain valve (hot water)

The safety drain valve opens automatically at temperatures between 4 and 7 degrees to avoid damage due to freezing.

The manual drain valve is operated by hand.

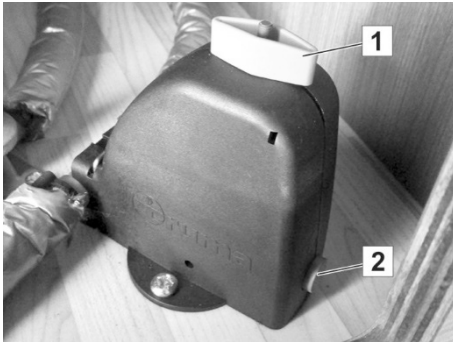

Fig. 107: Safety drain valve open

- Open safety drain valve manually:

To the top rotary switch (1) until it engages. A push-button (2), which is located at the bottom of the housing, will pop out (→ observe applicable operating instructions).

- Close safety drain valve:

When closing the valve, the push-button must be pressed and the rotary knob must be turned simultaneously 90 degrees. The push-button must remain in this position; otherwise, the valve will remain open.

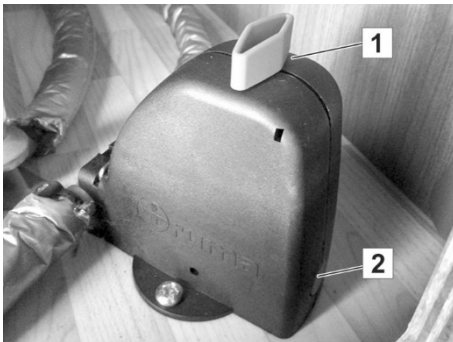

Fig. 108: Safety drain valve closed

6.1.4 Draining the waste water

NOTE



Cleaning agents, soaps, wash lotions and cosmetics contaminate the environment and ground water.

- *Never drain waste water in free nature, dispose only at the designated disposal points!*
- *Ensure that the collection container does not overflow, regularly empty at the disposal point.*

Drain via the discharge pipe

1. Place collection containers (e.g. water bucket) directly under the drain pipe under the floor of the vehicle.
2. Allow the waste water from the kitchen sink, shower, and wash basin to drain into the collection container.
3. If the camping place is equipped with a waste water system, you can extend the drain pipe using a suitable waste water hose, and directly route the waste water into the designated sewage system.

Waste water drain with permanently installed waste water tank (SW)

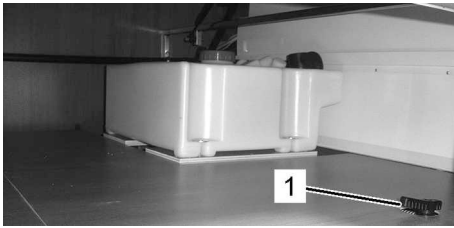

Fig. 109: Draw-off tap (1)

1. Place a collection container below the drain pipe under the vehicle (or discharge into designated waste water system, if available).
2. Open the draw-off tap (1) next to the waste water tank.
3. Drain waste water from the tank (tank volume: 44 litres!), into the collection container (or directly into the waste water system). Make sure that the collection container does not overflow.
4. Empty the collection container at the designated point of disposal.

Draining via the waste water tank (optional)

- Available if this special option was selected.



Fig. 110: Wheeled waste water tank

1. Detach the wheeled waste water tank from its bracket in the gas bottle locker and open the cover.
2. Place the wheeled waste water tank with the intake port under the drain pipe for the waste water to flow from the caravan into the tank.
3. Regularly empty the waste water tank at an approved disposal point before it may overflow.
4. After use and before continuing your trip, insert the waste water tank in its bracket in the gas bottle locker and fasten.

6.1.5 Changing the gas bottle

- For the standard model of the gas system (flexible gas hose and pressure reducer) change the gas bottle as follows:

WARNING



Danger of explosion and injury due to gas!

Escaping gas can cause poisoning and explosions.

- All repairs on the gas system must be performed only by authorised specialist personnel.
- If gas odour is detected:
 - Immediately shut down the gas supply.
 - Do not operate any electric devices.
 - Remove fire and sources of ignitions.
 - Do not smoke.
 - Have gas system repaired immediately.



Fig. 111: Gas bottle with pressure reducing valve

1. Open the gas bottle box.
2. To change an empty gas bottle, close the gas bottle valve of the empty bottle.
3. Manually unscrew the union nut of the gas bottle valve (note left-handed thread).
4. Loosen the fastening belt of the gas bottle and remove the bottle from the gas bottle locker.
5. Inspect the gas hose. If it is porous or damaged, have it replaced by qualified personnel.
6. Place the new gas bottle in the gas bottle locker and secure with fastening belt.
7. Manually screw the union nut of the pressure reducing valve tightly onto the gas bottle valve (note left-handed thread).
8. Close the gas bottle locker and engage the lock.
9. In order to operate the gas appliances, open the gas bottle valve and the applicable quick-action valve.

6.1.6 Replacing the gas bottle (DuoControl CS) (optional)

- In Control CS (with Eis-Ex and remote display) comply with the following instructions:

WARNING



Danger of explosion and injury due to gas!

Escaping gas can cause poisoning and explosions.

- All repairs on the gas system must be performed only by authorised specialist personnel.
- If gas odour is detected:
 - Immediately shut down the gas supply.
 - Do not operate any electric devices.
 - Remove fire and sources of ignitions.
 - Do not smoke.
 - Have gas system repaired immediately.



Fig. 112: DuoControl CS gas supply

1. Open the gas bottle box.
2. Close the bottle valve of the empty gas bottle.
3. Manually unscrew the union nut of the high-pressure hose at the gas bottle valve (note left-handed thread).
4. Loosen the fastening belt of the empty gas bottle and remove the empty bottle from the gas bottle box.
5. Place the new gas bottle in the gas bottle box and secure with the fastening belt.

CAUTION



Gas leak if the gasket is damaged!

If the high-pressure hose is overtightened, the gasket may become crushed, causing a leak.

- Use only the supplied tool to attach and detach the high-pressure hoses! It ensures the correct tightening torque and prevents damages to the screw joints.

Camping

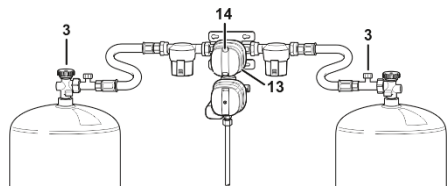

Fig. 113: Gas pressure regulator set

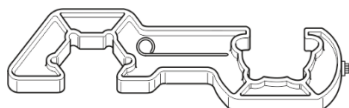

Fig. 114: Supplied assembly/removal tool

6. Screw the union nut of the burst hose safety-valve (3) on to the gas bottle valve using the supplied tool.
7. Inspect the gas hose at the gas bottle valve, at the pressure regulator, and over the entire hose length: If it leaks, is porous or damaged, do not operate the gas bottle! The gas hose must be replaced by specialised personnel.
8. At the rotary knob (13), set the function of the gas bottles; for example turn the rotary knob fully to the left:
 - left gas bottle = active bottle
 - right gas bottle = reserve bottle

NOTE



The colour display in the view window (14) shows the current operating status:

- Green = Gas consumption from the active bottle
- Red = Gas consumption from the reserve bottle

9. To operate gas devices, open the gas bottle valves and release the gas pressure regulator (→ Releasing the gas pressure regulator).
10. Close the gas bottle box and engage the lock.

Releasing the gas pressure regulator

After each opening of the gas bottle valves, the gas pressure regulator must again be enabled.

1. Open the gas bottle valve (if you use two bottles: open both bottle valves).
2. In two-bottle operation: press and hold the safety valve of the active bottle.

Setting the remote display (optional)

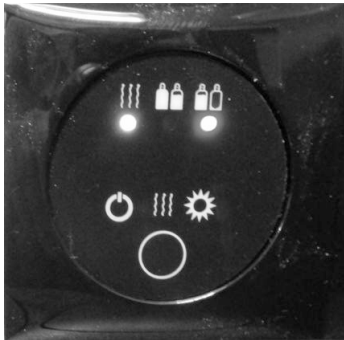

Fig. 115: Remote display

If a remote display has been installed in the vehicle interior, select the operating mode by activating the switch in the centre:

- Summer operation
- Winter operation

The illuminated displays in the ornamental ring mean:

- Green LED = Gas consumption from the active bottle
- Red LED = Gas consumption from the reserve bottle
- Yellow LED = Regulator heater active

Switching the gas bottle

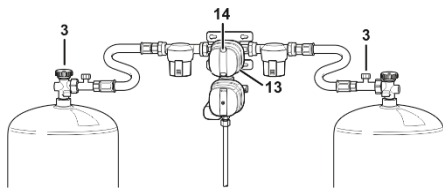

Fig. 116: Gas pressure regulator set

If the bottle pressure of the operating bottle drops below 0.5 bar, the gas pressure regulating set automatically switches to the reserve bottle. In the view window the display changes to red.

NOTE



In cold weather or if there is significant gas consumption over a longer period, gas pressure can drop below 0.5 bar, although gas is still in the bottle. Thus, it can happen that gas is withdrawn from both gas bottles.

The position of the rotary knob (13) can be changed at any time as needed.

- Always turn the rotary knob (13) to the right or left all the way to the stop. The middle position is for simultaneous withdrawal from both gas bottles.

Single-bottle operation

you can operate the gas supply with only one bottle. Check valves prevent the outflow of gas from the unassigned connection.

1. In single-bottle operation, close the free connection with the supplied brass blind-off cap.
2. Set the rotary knob at the gas pressure regulator set to the active bottle.

Camping

6.1.7 Gas supply maintenance (general)

- Repeat the gas supply inspection pursuant to applicable regulations (every two years in Germany, for example).
- Replace the gas pressure regulator set and the hoses at the latest ten years after their manufacturing dates.

6.2 Airing

General

Regular and planned airing creates a pleasant atmosphere and prevents condensation formation and heat accumulation.

Use the hinged windows, sliding windows and skylights to air the motor caravan superstructure.

The caravan features forced ventilation openings to ensure continuous airing.

ATTENTION



Damage due to inadequate ventilation!

Inadequate ventilation causes a lack of oxygen and worsens the room climate. Heat accumulation and water condensation cause damage to the interior furnishings.

- Never cover the louvres for forced ventilation.
Always ensure adequate airing of the vehicle.
-

Hinged window



Fig. 117: Hinged window

Intensive airing

1. Turn the rotating knob upward by approximately 90°.
2. Swing the window outward and latch in the desired position or fasten with the locking mechanism.
3. To close the hinged window, swing further upward or undo the locking mechanism.
4. Swing the hinged window backward, close it and lock with sash fastener.



Fig. 118: Continuous ventilation

Continuous ventilation

1. Turn the rotating knob upward by approximately 90°.
2. Push the window outward by approximately one to two centimetres (one inch).
3. Turn the rotating knob back in order for the locking catch to insert in the recess of the window latching mechanism.

Close:

4. After airing, turn the rotating knob again upward until the locking catch can leave the recess.
5. Pull the window into the frame. To lock, turn the rotating knob downward by approximately 90°.

Sliding windows



Fig. 119: Sliding windows

Opening sliding windows

- To open, press the inner slide handle to the side and hold; at the same time slide the moveable part of the window to the side.
- To close, push the moveable window part back into position. When closing, always ensure that the slide handle again engages.

Camping

Combination blind



Fig. 120: Combination blind

The hinged windows are fitted combination blinds consisting of a fly screen and a blackout blind. Both blind components are hung from the window top.

For both blinds:

- To close, use the handle to pull the fly screen fully downward and slightly push against the window until the lower strip latches.
- To open, push the handle downward and slightly pull toward yourself until the lower strip detaches. Due to the tension, the blind automatically rolls up – hold the handle during this action.

The blackout blind can be lowered in three different heights. It latches in one of three possible positions in the lateral guide rails.

ATTENTION



Damage to the blinds if they fly up!

To avoid damage to the blind, ensure that the blind **CANNOT** fly up.

NOTE



Do not keep the blind closed during driving and over a longer period of time (several weeks).

Over time, the springs would suffer if the blinds are permanently lowered.

Re-tensioning the blinds

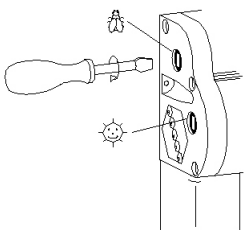

Use a screwdriver to re-tension the blind springs.

- Insert the screwdriver and turn once or twice clockwise.
- Check the tension and repeat the process, if required. Ensure that you don't over-tension the springs.

Blind care

As a rule, never use aggressive cleaning agents (solvents or abrasives). Use a damp cloth and soapy water to clean the blinds and frame parts. Use a soft brush and/or damp cloth to clean the fly screen.

Fly screen door (optional)



Fig. 121: Fly screen door

The entrance door can be fitted with an optional fly screen door (optional).

1. To open the screen door, push the handle into the desired position.
2. To close the screen door, push the handle back.

CAUTION



Damage due to incorrect use!

When entering and exiting the vehicle and when closing the entrance door, the fly screen may be damaged by the waste container.

- Always return the extended fly screen back into the holder first!

Camping

Skylight

Depending on the caravan model, the skylights installed in the roof differ in design and operation.



Fig. 122: Prop-up skylight

Opening the prop-up skylight

1. Grasp both handles to push the internal locking levers.
2. Grasp both handles and push the skylight upward.

Closing the prop-up skylight

1. Grasp both handles to push the internal locking levers.
2. Grasp both handles and pull the skylight downward.



Fig. 123: Operating the Skylight
400x400 mm /
VisionStar 700x500 mm

Opening the skylight

1. With the VisionStar, pull and/or turn the handle down so that the skylight unlocks.
2. Push the pulled down handle forwards so that the skylight lifts up.
3. Latch the clip in the desired position.

Closing the skylight:

- Move the handle back from the latched position into the initial position.



Fig. 124: Operating the Midi Heki / Mini Heki plus

Opening the skylight

1. Press the safety button (1) of the skylight.
2. Move the clip (2) in the guide groove (3) backward.
3. Latch the clip in the desired position.

Closing the skylight:

- Move the clip from the latching position back to its original position until the safety button (1) locks the skylight.

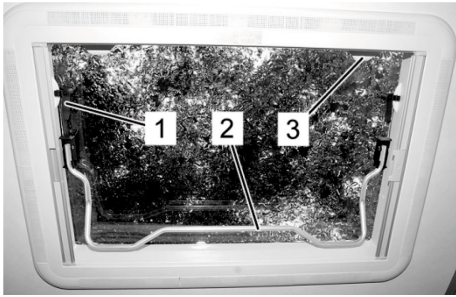

Fig. 125: Operating the Heki 2 lift skylight

Operate the lift skylight (optional)

1. Push the safety button on both knobs (1, left and right) and rotate the knobs approximately 90°.
2. Pull the clip (2) with a slight jerk from its bracket and swing downward.
3. Prop the skylight open with the clip. Swing the clip all the way down.
4. Place the clip onto the bracket (3) and secure.

6.3 Heating and water heating

6.3.1 TRUMA heater

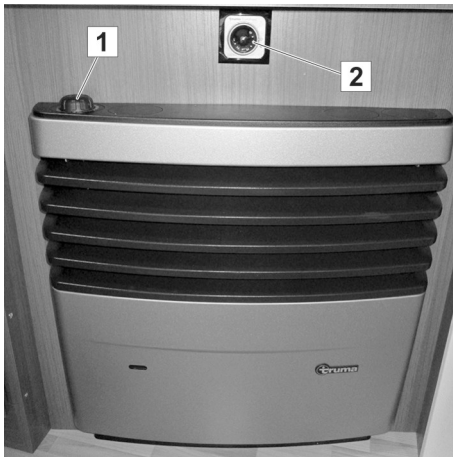

Fig. 126: TRUMA heater

The vehicle is always equipped with a gas heating system. It is operated via the thermostat (1).

The gas heater generates hot air that is distributed in the caravan body via a hot-air pipe system. The hot-air blower is operated with the operating switch (2) directly mounted above the heater.

The hot air blower will work only when an external 230V power supply is connected.

NOTE



In many countries, the operation of gas heaters during driving is not allowed. Before starting the trip, obtain information about the locally applicable regulations on the transit route and at the destination. If in doubt, close the gas heater prior to starting the trip, as well as the quick closing valve and gas bottle valve.

WARNING



Danger of fire!

Overheating the heating element can cause fire resulting in severe burns.

- Do not keep heat-sensitive items (such as aerosols) in the heater's vicinity.
- Do not place textiles in front or on the heating elements.

Camping

Start-up

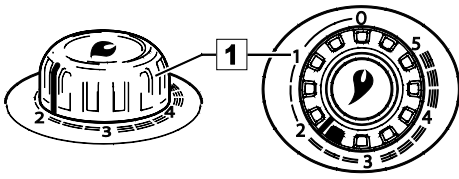

Fig. 127: Thermostat

Gas heater with automatic ignition

1. Open the gas bottle and the quick-action valve in the gas feeding line.
2. Turn the multi-function thermostat (1) to one of the thermostat settings 1 – 5 and push until the stop. The system ignites automatically (audible spark) until the flame burns.

NOTE



The sparks of the automatic ignition are audible when you hold the thermostat button down. The heating element is automatically ignited after some seconds (up to approximately two minutes).

3. Continue to press down the thermostat button for another ten seconds to ensure that the safety pilot responds.

ATTENTION



Risk of deflagration!

Unconsumed gas in the heating element may deflagrate and damage the heater!

- If the gas does not ignite, wait for at least two minutes before again attempting to ignite the element.

NOTE



If the flame dies after ignition, the system automatically re-ignites during the closing period of the safety pilot (approximately 30 seconds).

- If no flame is achieved, the automatic ignition will continue to work until you switch the thermostat to "0".
- If the gas line contains air, the system may require up to two minutes before gas is delivered for consumption. During this time, keep the thermostat button pressed until you have a steady flame.
- To obtain a uniform and fast distribution of warm air and a lowered surface temperature at the warm air outlet grid, we recommend that you operate the heater with the TRUMA warm air system running.

Room thermostat

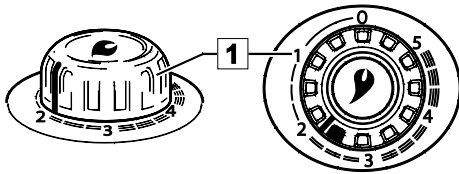

Fig. 128: Thermostat

The room thermostat regulates the heater output according to the setting at the thermostat installed at the heater's top.

NOTE



The temperature sensor is installed at the bottom of the heater. Cold draughts, door gaps, carpeting, etc. affect the thermostat action. Eliminate any problems if you experience unsatisfactory temperature regulation.

A mean room temperature of approximately 22 °C can be achieved without blower operation at a thermostat set to 3. We recommend an operation with blower and thermostat setting 4 to achieve a comfortable warm air distribution and lower condensation at cold surfaces.

The exact thermostat setting must be determined and adjusted according to the vehicle model and individual needs.

Switching off

1. Set the thermostat handle of the heater (1) to "0". The automatic ignition is automatically deactivated.
2. Turn off the blower (set rotary switch to "0").

If the device will not be used for an extended time, close the quick-action valve in the gas feeder hose and the gas bottle.

Camping

Removing the heater grille

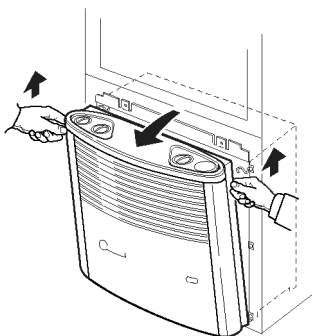

Fig. 129: Opening the heater grille

1. Slightly pull the heater grille top forward.
2. Push up the retaining springs at the sides and tilt the heater grille forward (Fig. 129).

NOTE



If space is sparse, pull the heater grille top slightly to the front and lift until it is free. Take off the heater grille.

3. Swing the heater grille to the side (Fig. 130).

Closing the heater grille

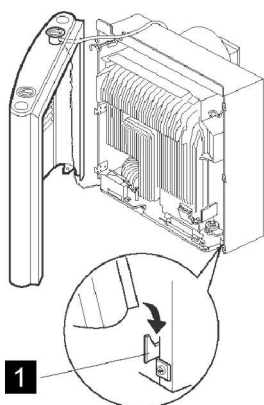

Fig. 130: Open heater grille

1. To install, place the heater grille onto the lower holding brackets (Fig. 130/1).
2. Insert the operating rod from below into the handle bush.
3. Swing the heater grille back and latch at the top.

NOTE



Designs with pressure igniter: Place the operating handle from the top so that the arrows points to the "0" position.

Battery change

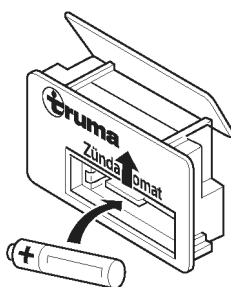

Fig. 131: Battery change

Heater with automatic ignition

- Replace the battery only when the heater is turned off.
 - Insert a new battery before every heating period.
 - Dispose of old batteries according to environmental regulations.
 - Use only heat-resistant and leak-free batteries (LR 6, AA or AM3)!
1. Remove the heater grille.
 2. Push the cover of the battery compartment upward.
 3. Replace the battery; ensure correct polarity.
 4. Close the battery compartment.
 5. Close the heater grille.

Cleaning

- Prior to every heating period, use a small brush or paint brush to remove the dust accumulated on the heat exchanger, the bottom plate and the fan wheel.

Hot-air nozzle



Fig. 132: Hot-air nozzle, open

To heat the caravan body, the blower drives hot air through the hot-air piping and expels the air through the hot-air nozzles into the caravan interior.

To regulate the flow of hot air as needed, the hot-air nozzles installed at various points can be manually opened or closed.

- To open and close bring the revolving dampers of the hot-air nozzles into the desired position.

Floor heater system (optional)



Fig. 133: On-Off switch of the floor heating system

The electric floor heating system (optional) is activated with the On-Off switch (1). It is located above the entrance door. The corresponding transformer is fitted in the bed frame or in the bench.

The floor heating system does not require maintenance.

WARNING



Risk of fire hazard due to damaged heating foil!

The heating foil is laid directly under the PVC carpet. There is a risk of fire if it is damaged.



- Therefore, for retrospective assembly or changes to the furniture layout, always have these modifications cleared in advance by your dealer.

Camping

6.3.2 ALDE- heater (optional)

Liquefied gas operation

1. Select "Liquefied gas mode" at the operating unit.
2. Open the gas shut-off valve for the heater.
3. Start the heater.

When you start the heater, the system automatically ignites the burner,

NOTE



The heater is active until the set temperature has been reached. If the flame dies within this time, the system automatically restarts after approximately ten seconds.

Operation with electric heater cartridge

1. Connect to a 230 V mains supply.
2. Select "Electric heating mode" and any available heating level at the operating unit.

The heater starts automatically at 230 V.

NOTE



For a faster heating of the vehicle, operate the system with gas and power at the same time. Electric operation will always have priority.

Check and replenish the expansion tank.

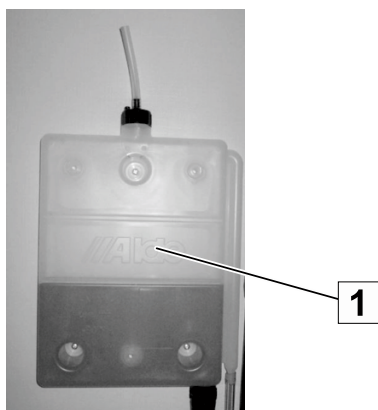

The filling level in the sight glass (1) of the expansion tank must be between "Min" and "Max" on cold state and may be slightly above "Max" in warm state.

The expansion tank must not run empty, otherwise, the heating system must be vented.

If the level falls below the "Min" mark, refill the tank as follows:

- Mixing ratio for ALDE heater: 50% water/50% glycol (recommended: aluminium radiator antifreeze Glysofor N)
- To prevent rust in the heating system, replace the glycol-water mixture every five years.

Fig. 134: Expansion tank

Operating the ALDE control unit

NOTE



- Switch off the heating system's main switch when the vehicle is not used.
- Don't splash water directly at the exhaust chimney when you wash the vehicle.
- When camping in winter, ensure that the exhaust chimney and the inlet and discharge valves are kept free of snow and ice.
- You can heat the heating system without having filled the hot water boiler with fresh water.
- You can operate the gas boiler and the electric heater at the same time.
- Always drain the fresh water from the hot water boiler when there is a risk of freezing and the vehicle is not used.
- The liquefied gas heater must not be in operation when you refuel the vehicle within a garage or similar environment.
- Never permit the heating system to be at standstill without glycol solution.

Starting the heater



Fig. 135: OFF



Fig. 136: ON

1. The operating unit and the heater are switched off.
2. Press the On/Off button to start the heater. The start screen appears. The heater starts with the last used settings.

Camping

Idle position

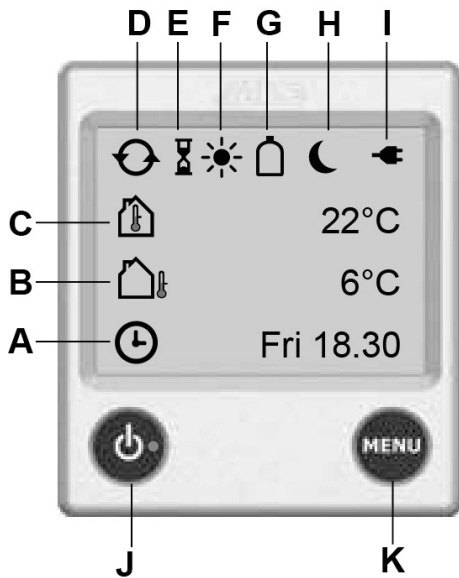

Fig. 137: Controls

- A Clock.** The clock displays date and time (if activated). For its setting, please see the ALDE operating manual.
- B Outside temperature*.** The outside temperature is displayed.
- C Inside temperature.** The inside temperature is displayed.
- D Recirculating pump.** This symbol is displayed when the recirculating pump is operating.
- E Automatic start of the heater.** This symbol is displayed when the function has been activated.
- F Day automatic.** This symbol is displayed when the function has been activated and the time is within the set period.
- G Liquefied gas bottle full/empty*.** This symbol is displayed when the sensor at the gas regulator is connected to the bottle and activated. If "Eis-Ex" is installed, the symbols for the set mode is shown with the bottle symbol.
- H Night automatic.** This symbol is displayed when the function has been activated and the time is within the set period.
- I 230 Volt.** This symbol is displayed when 230 V voltage is applied to the heater.
- J On/Off button.** Main switch for the heater.
- K MENU button.** Button to open the Settings menu.

The functions identified with (*) are optional equipment.

Settings menu



Fig. 138:
Operating unit in
idle state



Fig. 139:
Operating unit with
Settings menu

1. Press the MENU button to open the Settings menu.
2. The background illumination activates and the adjustable functions are displayed.

The operating unit switches to idle if you don't touch the screen within 30 seconds.

Setting the required temperature



Fig. 140: Temperature setting

You can set the temperature in increments of 0.5 °C between +5 °C and +30 °C. You cannot adjust the temperature if the day or night automatic are active. The plus and minus symbols are displayed in grey.

1. The displayed temperature is the one set at this point.
2. Press "+" to raise the temperature. Press "-" to lower the temperature.
3. The settings are completed and the heating system will operate until the set temperature is reached.

Hot water

The heating system features a built-in hot water boiler with a volume of approximately 8.5 litres. You can use the hot water boiler even when you have no fresh water in the boiler. You have three options in the heater settings for setting the heater in respect to hot water requirements: "No hot water", "Normal mode" or "More hot water".

- **No hot water.** If you don't need hot water, press "-" (the symbol empties).

You cannot adjust the temperature if the day or night automatic is active and hot water is switched off. The plus and minus symbols are displayed in grey.



Fig. 141: No hot water

Camping



Fig. 142: Normal mode



Fig. 143: More hot water

- **Normal mode.** If fresh water is added and you want hot water, press "+" (the symbol is filled to the middle).

You cannot select this function if the pump is in continuous operation mode.

- **More hot water.** If more hot water is required, the water temperature can be temporarily increased to approximately 65 °C. Press "+" until the symbol is completely filled (black). The heater returns to normal operation after 30 minutes. The circulation pump does not run during heating.

If the pump is in continuous operation mode, the system disable the "continuous pump mode" function for 30 minutes. After this time has elapsed, the "continuous pump mode" is reactivated.

NOTE



If you only need hot water, for example, during summer operation when you don't need to heat, you don't need to adjust the settings. The heating system regulates this function automatically.

Heating with gas



Fig. 144: Heating with gas

If you select electricity and gas at the same time, you can set the priority for either electricity or gas (see the ALDE operating manual).

1. Press the "liquefied gas flame" symbol to start the gas mode. The symbol for liquefied gas becomes active and changes to green.
2. The heater operates until the set temperature is reached.
3. Press the "liquefied gas flame" symbol again to end the gas mode. The symbol for liquefied gas is deactivated and changes to blue.

Heating with electricity



Fig. 145: Heating with electricity

The higher the selected capacity, the faster the heating process. If you select electricity and gas at the same time, you can set the priority for either electricity or gas (see the ALDE operating manual).

1. Start and incrementally change the various heating levels (Off, 1 kW, 2 kW or 3 kW) with "+" or "-". The set value is displayed on the screen. Upon activation, the plus sign is shown in green. If the load monitor function* is installed and set, the heater will not use any more electricity as required, even if you have selected 3 kW.
2. The heater operates at the set temperature.
3. Press "-" until "Off" appears to switch off the electric heating mode.

Activated functions

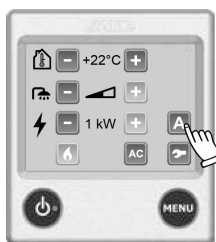

Fig. 146: Idle position



Fig. 147: Activated functions

Press "A" to display the individual activated functions. You can now select an individual function to change the settings.

The "A" symbol is only visible when you have activated and/or installed a particular function.

Camping

Tools menu



Fig. 148: Tools menu

Open the Tools menu from the Main menu. In the Tools menu, you can change the remaining functions of the operating unit.

- Click the "wrench" symbol in the Settings menu to open the Tools menu.

NOTE



For additional functions of the operating unit, please see the separate ALDE manual.

ALDE control knobs

A control knob for the ALDE heater is located in the sleeping area.

The heater's temperature is controlled with the operating unit. The heat output of the heater in the sleeping area can be continuously adjusted using the control knob as an extension of the operating unit.

6.3.3 Water heater

ATTENTION



Damages after extended stand time or frost!

If the vehicle is not used in winter, the sanitary system may be damaged due to frost.

Extended stand times can cause algae growth in the sanitary system.

- Ensure that the overflow valve is free from contamination and ice formation.
- In the event of frost or extended stand time, completely empty the water tanks, containers, hoses, and conduits. Dry-run the pump for approximately five minutes to avoid frost damage caused by residual water in the pump.

NOTE



Frost damage or contamination caused by algae growth in the water system are not covered by the guarantee!

Mixer tap



Fig. 149: Mixer tap

WARNING



Danger of scalding due to hot water!

Hot water can scald hands and other body parts.

- Open the mixer tap in cold-water position and carefully raise the temperature.

1. To obtain water, turn the lever in direction of the cold-water setting (blue mark), lift upward, and slowly shift in direction of the red mark.
2. To close, turn the mixer lever in direction of the blue mark and push downward.

Camping

6.3.3.1 TRUMA heater and TRUMA water heater system

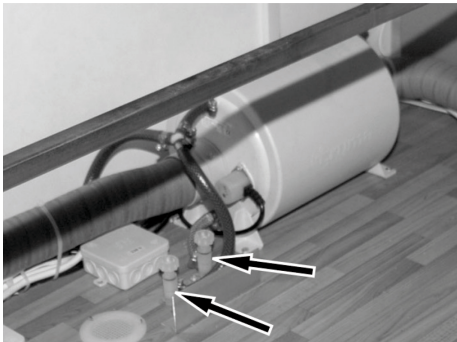

Fig. 150: Drain valves

Filling the hot water heater

1. Fill the cold water tank (→ "Filling with cold water").
2. Turn on main switch (power supply).
3. Close cold and hot water drain valves.
4. Open mixer tap in kitchen or bathroom in "hot water" position.
5. Close mixer tap as soon as water starts running.
6. Switch on the hot-water food warmer.

NOTE



After filling the hot water heater, cold water will be released from the mixer tap at first because the water is not yet heated.

To ensure the heating phase remains short, the hot-water food warmer must be regularly descaled.

Emptying the hot water heater

If there is danger of frost or the fresh water system is not in use, drain water as described below:

1. Turn off the hot air blower of the gas heater.
2. Turn off the electric heater of the hot water heater.
3. Turn off main switch (power supply).

WARNING



Danger of scalding due to hot water!

When emptying the hot-water heater, hot water can escape and may cause severe scalding injuries on hands and skin.

- Prior to draining the water from the hot water heater, cool water to ambient temperature.

4. Open the drain valves.
5. Drain fresh water (→ "Draining fresh water").

NOTE



For servicing and care instructions for the water heating units, please refer to the enclosed unit operating instructions.

6.3.3.2 With installed ALDE heater (optional)



Fig. 151: Closed drain valves

1. Close the combined drain valve at the freshwater tank.
2. Close drain valves for cold and hot water pipes.
3. Fill fresh water tank.
4. Fill the boiler. Turn the mixer lever of the mixer tap in direction of the hot water setting (red mark) and pull upward. Cold water is pumped from the fresh water tank into the boiler.
5. Close the mixer lever after all air has been expelled from the water pipe and cold water flows.
6. Start the heater.

Hot water will be available after approximately 30 minutes.

NOTE



To ensure the heating phase remains short, the boiler must be regularly descaled.

6.4 Sitting and sleeping

6.4.1 Converting the sitting area

The layout of the sitting area depends on the selected model. By lowering the table, you can create additional sleeping spaces.



Fig. 152: Table, rectangular

Lowering a table with support leg

1. Push the sliding bush (1) upward and fold the lower part of the table leg (2).
2. Tilt the table top upward and lift from the wall rail (3).
3. In tilted position, hang the table top in the lower wall rail (4).
4. Tilt the table top forward until the folded leg is securely placed on the floor.

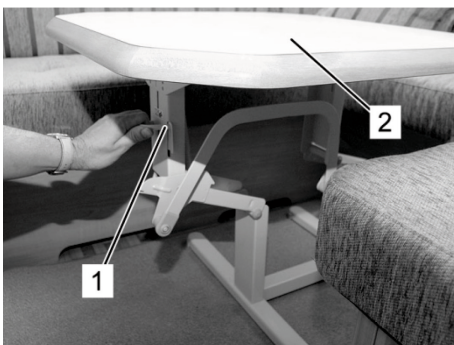

Fig. 153: Table with table lift frame

Lowering a table with lift frame

1. Turn handle (1) counter-clockwise and hold to unlock the folding mechanism.
2. Push the table top (2) downward.
3. After latching the lower position, release the handle (1).

"Ilse-Lift" lifting frame (optional)



Fig. 154: "Ilse-Lift" lifting frame

Functions:

- Lowerable single leg table foot
- Rotating table plate

Raising the table

- Swivel operating lever (2) through 180 degrees.
The table automatically raises to its normal position.
Once the desired height of the tabletop is reached, lock the operating lever again

Rotating the tabletop

- After loosening the knurled screw (1) the tabletop can be rotated and aligned.
(Only if the lifting table is extended)
The knurled screw must be tightened again after aligning the tabletop.

Lowering the table

- Before lowering the table, swivel it back into the home position. After swivelling, re-tighten the knurled screw.
Then activate the operating lever (2) to lower the table.
- Swivel the operating lever (2) through 180 degrees and simultaneously push the tabletop downward.
Once the desired height of the tabletop is reached, lock the operating lever again.

Camping

“Click-clack” lifting frame (optional)



Functions:

- Lowerable single leg table foot
- Rotating table plate

Raising the table

- Raising of the table by pressing the table plate twice (pressing releases the lock = click, pressing down = clack)

Swivelling the table plate

- Swivel the table plate by undoing the knurled screw below the table

Lowering the table

- Lowering or raising of the table by pressing the table plate twice (pressing releases the lock = click, pressing down = clack)



Fig. 155: “Click-clack” lifting frame

6.4.2 Folding console as bed extension

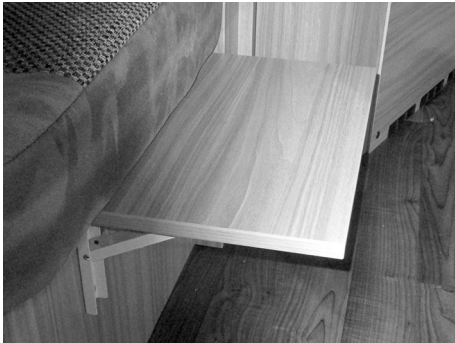

Fig. 156: Folding console as bed extension

Depending on the model, a folding console may be installed as an extension of the bed.

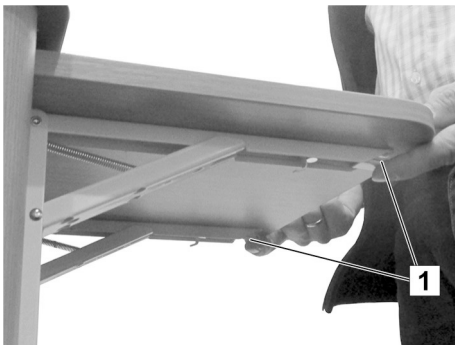

Fig. 157: Undoing the latching mechanism

Folding the folding console

- Push both latches (1) upward at the same time and fold the console downward.

Opening the folding console

- Lift the folding console upward until both latches (1) have latched.

Camping

6.4.3 Sitting group conversion to a sleeping area



Fig. 158: Round sitting group

The free surfaces must be padded out with additional (optional) cushions to provide a continuous sleeping surface.



Fig. 159: Round seating group with filling cushions

The round seating group is padded out with additional (optional) cushions.

Dinette with hook-in table



Fig. 160: Table with hinged table foot



Fig. 161: Table foot folded in

Raise table, fold in hinged table foot.

Camping



Raise the table further until it can be taken out of the upper rail and hook back into the lower rail.

Fig. 162: Hook table into lower rail.



Pad out the free surface with additional cushions (optional).
Pull the seat cushion out to the table and turn over a back cushion to obtain a closed sleeping surface.

Disassembly back to the seating group takes place in the reverse sequence.

Fig. 163: Sleeping area with cushions.

6.4.4 Setting up the lighting

Depending on the selected model and equipment, the living and sleeping areas are fitted with various lamps.

Adjusting brightness

The brightness of the living area lamps can be adjusted as required.

- Press the light buttons on the multifunction switch and hold until the desired brightness is set.
- To simply switch the lights on/off without regulating brightness, briefly press the respective light button once.

Switching the bathroom and kitchen light

Bathroom and kitchen lights have their own ON/OFF switches in the vicinity of the respective lamps.

These light fixtures cannot be switched from the multifunction switch and have a fixed brightness.

Adjusting the LED spot light



Fig. 164: Adjusting the LED spot light

The LED spot lights in the rail system can be adjusted:

1. Use the base switch to turn off the LED spot light.
2. Turn the base by 90 ° so that the base is at a right angle to the rail (→ Fig. 164).
3. Pull the LED spot light down to remove it.
4. Insert the LED spot light at another location in the rail.
5. Rotate the base back 90° to reposition the base lengthwise in the rail.

The LED spot light can now be switched on again via the base switch.

Camping

6.4.5 Opening and closing the pop-up roof

Safety instructions

DANGER

**Life-threatening danger due to lightning!**

During a thunderstorm, any persons in the pop-up roof can suffer life-threatening injury.

- Never stay in the pop-up roof during thunderstorms.

WARNING

**Danger of injury due to falling!**

When sleeping, playing, or if they are in the pop-up roof unattended, small children can fall through the passage and suffer broken limbs and permanent bodily injury.

Persons with limited mobility can fall when climbing up and climbing down or can injure themselves in the hinged pop-up roof.

- The pop-up roof is not suited for unsupervised use by children under six years.
- Persons with limited mobility should avoid using the pop-up roof.

CAUTION

**Health damages due to exhaust gases!**

In adverse wind conditions, the heating system's exhaust gases may be drawn into the sleeping area.

- Close all tent windows when operating the heater.

ATTENTION

**Risk of fire due to the ceiling light**

The ceiling light may scorch the interior furnishings.

- Turn off ceiling light after every use.

Care tips**NOTE**

Thoroughly vent the roof bellows several times during the season, to prevent stagnant moisture and musty smells.

Do not fold the pop-up roof in damp or wet condition immediately after rainfall, for example.

Prior to longer periods between use, remove the bed pad from the pop-up roof to avoid stagnant moisture and mildew.

Also observe the care tips in section 7.3 on page 170!

Opening the pop-up roof**CAUTION****Risk of damage to the pop-up roof!**

Sharp-edged and pointed objects may cause rents, dents or holes in the pop-up roof and rip the expansion bellows during unfolding.

- Before unfolding, check that no roofs, eaves, masts, pipes, overhead wires, signs, trees, branches or other objects may touch the unfolded roof.

CAUTION**Risk of damage to the expansion bellows!**

The unfolded pop-up roof offers a large target for winds and gusts. Strong winds at the coast or in the mountains for example, can rip the expansion bellow and damage the pop-up roof.

- Always park the vehicle with the wind and the lower roof side facing the wind direction.
- Ensure that the pop-up roof is closed whenever you leave the vehicle, or in the event of stormy weather.

Camping

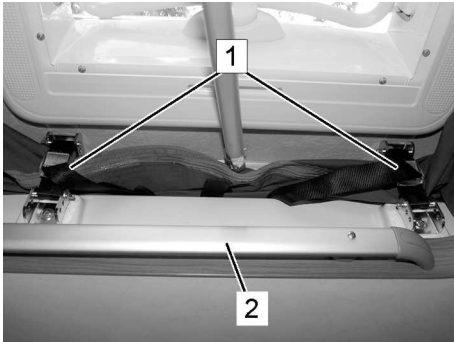

Fig. 165: Opening the pop-up roof

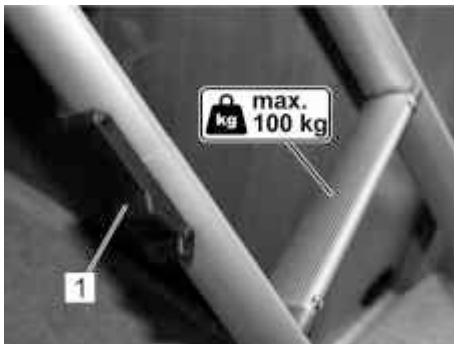

Fig. 166: Locking mechanism (1) of the access ladder

1. Park the vehicle in a position appropriate to the prevalent wind situation.
2. Remove any loads on the roof.
3. Open the access hatch.
4. Assemble both parts of the access ladder and interlock the components (Fig. 166/1).
5. Hang the access ladder in the corresponding rail (Fig. 165/2) in the access and solidly anchor on the floor.
6. Open the roof latches (Fig. 165/1).

CAUTION



Risk of damage to the roof canopy!

The roof canopy may be damaged when the pop-up roof is pushed up.

- Never press against the roof canopy!

7. Carefully push the rod at the rope against the GFRP shell until the pneumatic springs automatically lift the pop-up roof.
8. Always close the access hatch from above when sleeping in the pop-up roof.
9. Do not touch the interior of the expansion bellows or place objects against them (such as bedding) as water may permeate.

CAUTION



Risk of injury if the ladder is used incorrectly!

If the ladder is used incorrectly, there is a risk of injury due to falling.

- When climbing up or down, always hold the ladder firmly.
- Never climb or descend the ladder with your back to the ladder.
- The ladder must not be stood on by more than one person at a time.
- Never exceed the maximum permitted load (100 kg).

Folding the pop-up roof

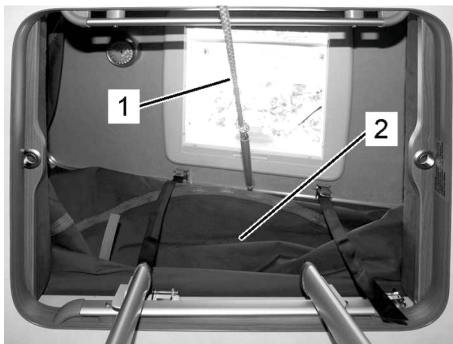

Fig. 167 Pulling rope (1), Expansion bellows (2)

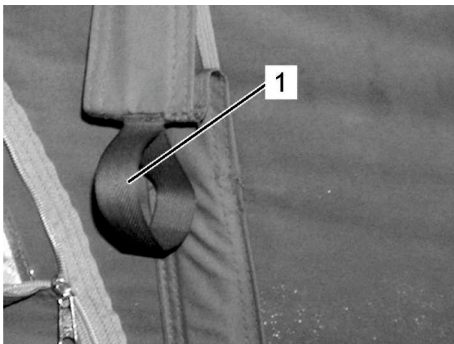

Fig. 168 Loops (1)

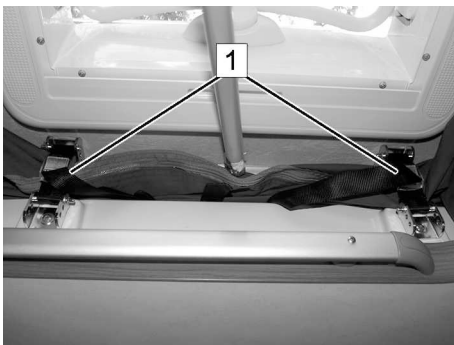

Fig. 169: Roof locking mechanisms

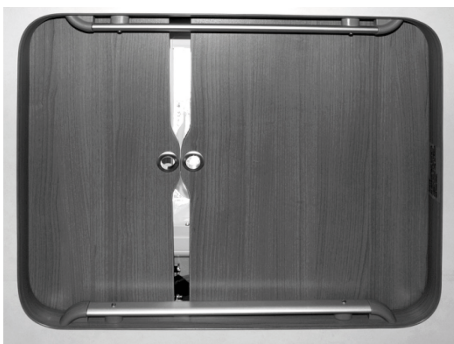

Fig. 170: Access hatch

1. Fully close the venting windows and zips.
2. Open the roof canopy to prevent overpressure in the pop-up roof during the folding process. This would push the expansion bellows to the outside.

CAUTION



Risk of injury when exiting!

Jumping from the pop-up roof may cause injuries due to breaking objects.

- Never jump from the pop-up roof to the floor or climb down without checking where you step.
- Do not step on furniture or the covers of the hob or sink.
- Always use the access ladder to exit the pop-up roof.

3. Before closing the pop-up roof, remove any items that could put pressure onto the roof shell (blankets, sleeping bags, clothing, etc.) and leave the pop-up roof.

ATTENTION



Risk of damage to the expansion bellows!

When folding, the expansion bellows may be pinched between objects and damaged.

- Always ensure during folding that the expansion bellows properly fold to the inside and is not pinched between the outer edges of the pop-up roof, pneumatic springs, chassis components or between the roof locking mechanisms.

4. From the access ladder, use the pulling rope (Fig. 167/1) to slowly pull the pop-up roof down. Very carefully use the lateral loops (Fig. 168/1) to pull the expansion bellows to the inside and ensure no pinching of the bellows between objects and components.
5. Look around the vehicle's exterior to ensure that the bellows nowhere hangs outside.
6. Securely brace the pop-up roof with the roof locking mechanisms (Fig. 169/1).
7. Stow the access ladder and pulling rope; and close the access hatch (Fig. 170).

Camping

6.5 Bathroom

6.5.1 Using the shower and washbasin

The shower and washbasin are supplied by the heating system or a hot water boiler (optional).

- Activate the mixer tap to draw hot water.

6.5.2 Flushing the toilet with fixed installed toilets (optional)



1. Before flushing, open the slide gate of the waste holding tank. Pull the lever (3) forward.
2. Press the blue push-button (1) to flush.
3. After flushing, push the lever (3) backward to close the slide gate of the waste holding tank.
4. Monitor the filling level on the display (2), empty if required.

Fig. 171: Cassette toilet

Emptying the waste holding tank



Fig. 172: Waste holding tank in the disposal shaft

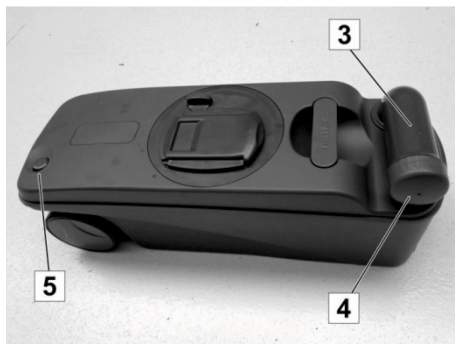

Fig. 173: Emptying the waste holding tank

NOTE



The waste holding tank must be emptied at the latest when the fill level indicator next to the flushing button is illuminated.

Completely empty the holding tank if there is danger of freezing and the caravan superstructure is not heated.

NOTE



Faeces and chemicals harm the environment.

- *Drain the waste holding tank only at the designated disposal stations.*

1. Close the slide gate at the toilet bowl.
2. Open the sanitary compartment at the outside of the caravan body.
3. Press the coloured bracket (1) and use the handle (2) to pull the tank from the disposal shaft.
4. At a designated disposal station, swivel the discharge pipe (3) to the side and unscrew the cap (4).
5. Press and hold the coloured button (5) of the venting valve and empty the waste holding tank.
6. Use fresh water to clean the tank, replace the cap on the discharge pipe and return the pipe to its position.
7. Push the waste holding tank into the disposal shaft until the bracket latches.
8. Lock the sanitary compartment.
9. Refill with new sanitary fluid.

6.5.3 Flushing the toilet with revolving toilets (optional)

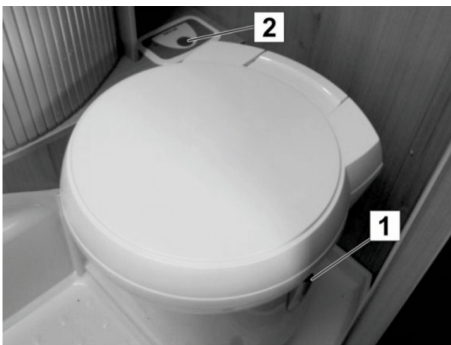

1. Manually rotate the toilet seat in closed state into the desired position.
2. To flush, turn the lever (1) at the toilet bowl side counter-clockwise.
3. Push the flushing button (2). The operating panel is activated.
4. Push again the flushing button (2).
5. After flushing, turn the lever (1) clockwise.

Fig. 174: Pivoting toilet

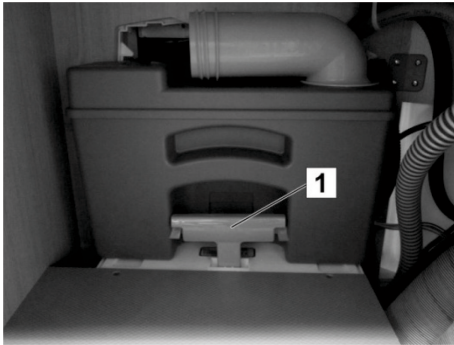

Fig. 175: Waste holding tank in the disposal shaft

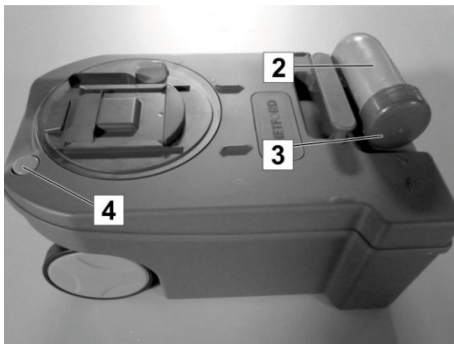

Fig. 176: Emptying the waste holding tank

NOTE



The waste holding tank must be emptied at the latest when the fill level indicator next to the flushing button is illuminated.

Completely empty the holding tank if there is danger of freezing and the caravan superstructure is not heated.

NOTE



Faeces and chemicals harm the environment.

- *Drain the waste holding tank only at the designated disposal points.*

1. Close the slide gate at the toilet bowl.
2. Open the sanitary compartment at the outside of the caravan body.
3. Use the handle (1) to remove the waste tank from the disposal shaft.
4. At a designated disposal station, swivel the discharge pipe (2) to the side and unscrew the cap (3).
5. Press and hold the coloured button (4) of the venting valve and empty the waste holding tank.
6. Use fresh water to clean the tank, replace the cap on the discharge pipe and return the pipe to its position.
7. Push the waste holding tank into the disposal shaft until the bracket latches.
8. Lock the sanitary compartment.
9. Refill with new sanitary fluid.

NOTE



Emptying of the DOMETIC waste holding tank takes place in the same way.

Camping

6.6 Kitchen area

6.6.1 Using the combination ceramic hob

WARNING



Burn injuries due to open gas flame!

Very high temperatures are present in the area around the gas flame, especially above it. Reaching into the area will result in burns.

- Always maintain a safe distance from the gas flame.

Minimum and maximum pot sizes

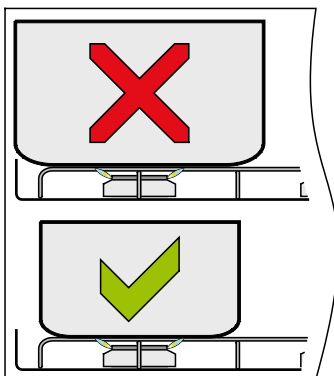

Fig. 177: Pot sizes

CAUTION



Risk of fire due to oversized pots!

Using oversized pots can cause overheating and thus a heightened risk of fire.

- Place the pots and pans centred above the burner.
- Used pots and pans must not be larger than the pan stand on top of the burner.
- The operating manual of the device manufacturer provides information about the permissible pot sizes.

NOTE



- *This device must be only operated with liquefied gas.*
- *Use only the specified gas pressure.*
- *This device is approved solely for the use with propane or butane gas.*
- *We recommend to use propane with this device.*
- *Using butane may lower the device output if the ambient temperature is less than 10 °C.*
- *Do not use butane if the ambient temperature drops below 5 °C.*
- *This device must be earthed.*

6.6.2 Cooker controls

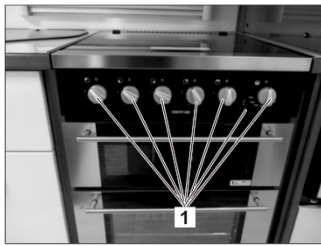

Fig. 178: Control elements

- Cooker controls (1)
- Control knobs of the burner, rear left (2), front left (3), front right (4) and rear right (5).
- Control switch for the grill (6)
- Ignition knob (7)
- Control switch (8) for temperature selection



Fig. 179: Burner control knobs

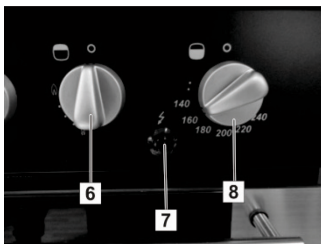

Fig. 180: Control switch for the grill, oven

Camping

6.6.3 Cooking



Fig. 181: 4-burner hob

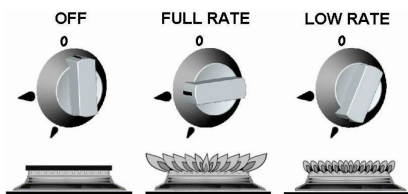

Fig. 182: Settings of the operating elements:
OFF, full heat, low heat

The gas cooker is located under a safety glass plate.

1. Lift the glass plate.
2. Make sure that the gas cylinder or the gas supply is connected and switched on. If there is a smell of gas, switch off the gas cylinder/the main supply and contact the manufacturer.
3. Flame control: Each burner is individually controlled and monitored by a thermal sensor. If the burner flames are accidentally extinguished, turn off the burner control knob and wait at least one minute until you re-light the burner.
4. Lighting: Press down the control switch and set it to the highest level (see Fig. 1). Hold a lit match or lighter against the burner and press down and hold the control switch. After the burner has ignited, press and hold the switch for about 10 - 15 seconds so that the thermocouple can reach the temperature before you release it. If the flame goes out when the button is released, repeat the procedure, holding the button a little longer.
5. The process is similar for models with spark ignition, except that the burner can be ignited by pressing the ignition button, which is located on the instrument panel. If the burner has not ignited within 15 seconds, release the control switch and wait at least one minute before making another attempt.
6. For simmering, turn the control switch further anti-clockwise until the lower level is reached.
7. Switching off: Turn the control switch until the line on the switch is in line with the dot on the instrument panel. Always make sure that the control switch is in the OFF position when the stove is no longer in use.
8. To shut down, turn the button until the line on the button is aligned with the dot at the control panel.

NOTE



After the flame extinguishes, the safety pilot valve automatically blocks the gas supply.

9. Close the "Cooker" quick-action valve and the gas bottle valve.
10. Wait until the hob has cooled down, clean, and cover with the glass plate.

NOTE

Each burner supports pans and pots with a diameter of 10 to 22 cm; make sure that the device is not overloaded, as this could lead to reduced performance.

We recommend the following maximum pot sizes:

Electric plate:- Ø180mm

Auxiliary burner:- Ø200mm

Half-speed burner:- 2x Ø200mm or 1x Ø220mm with 1x Ø180mm

When small pots or pans are used, the flames should not

be larger than the bottom of the pot, as this will reduce the efficiency of the burner.

Avoid old or bent pans or pots, as these may be unstable.

Before the hotplates are used, the covering plate must be opened completely.

Camping

6.6.4 Grilling



Fig. 183: Grill

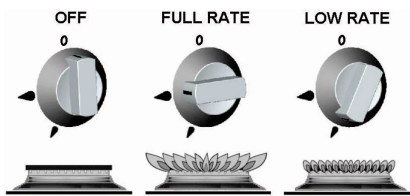

Fig. 184: Settings of the operating elements:

OFF, full heat, low heat

1. Make sure that the gas cylinder or the gas supply is connected and switched on.
If there is a smell of gas, switch off the gas cylinder/the main supply and contact the manufacturer.
2. Switching on: Open the door, press down the control switch and set it to the highest level (see Fig. 1). Hold a lit match or lighter against the burner and press down and hold the control switch. The burner should light and the control switch should be held down for about 10 - 15 seconds before it is released. If the flame goes out, repeat the procedure, holding down the button a little longer.
3. The process is similar for models with spark ignition, except that the burner can be ignited by pressing the ignition button, which is located on the instrument panel. The grill must be lit with the door open; if the burner has not ignited within 15 seconds, release the control switch and wait at least one minute before attempting to light the burner again.
4. Note: The grill may only be used with the door open.
5. When the grill is used for the first time, it should be heated for about 20 minutes to remove any residues of factory lubricants that could cause the cooked food to smell unpleasant. During initial use, non-toxic smoke may be produced; for this reason you should open all windows and switch on the mechanical ventilation or extractor hood to allow the smoke to escape.
6. Even if the grill heats up quickly, pre-heating for a few minutes is recommended.
7. Automatic gas cut-off device (FFD): The burner of the grill is equipped with a flame sensor that automatically cuts off the gas supply when the flame goes out. If the burner flames are accidentally extinguished, turn off the burner control knob and wait at least one minute until you re-light the burner. dot on the instrument panel. Always make sure that the control switch is in the OFF position when the stove is no longer in use.

8. With this burner it is normal for the flames to develop yellow tips when heating up.
9. Switching off: Turn the control switch until the line on the switch is in line with the dot on the instrument panel. Always make sure that the control switch is in the OFF position when the grill is no longer in use.

NOTE



The grill area can become hot when the oven is in use, even if the grill is switched off.

Take care when removing pans from the grill, i.e. always use oven gloves and the handle to remove the grill pan.

Camping

6.6.5 Baking



Fig. 185: Oven

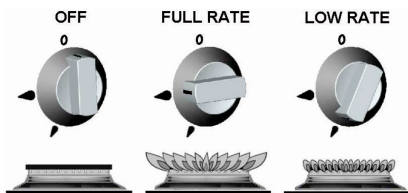

Fig. 186: Settings of the operating elements:

OFF, full heat, low heat

1. Make sure that the gas cylinder or the gas supply is connected and switched on.
If there is a smell of gas, switch off the gas cylinder/the main supply and contact the manufacturer.
2. Switching on: Open the door, press down the control switch and set to the highest level (240°C). Hold a lit match or lighter against the burner and press down and hold the control switch. The burner should light and the control switch should be held down for about 10 - 15 seconds before it is released. If the flame goes out, repeat the procedure, holding down the button a little longer.
3. The process is similar for models with spark ignition, except that the burner can be ignited by pressing the ignition button, which is located on the instrument panel. The grill must be lit with the door open; if the burner has not ignited within 15 seconds, release the control switch and wait at least one minute before attempting to light the burner again.
4. Move the oven grate to the desired position and close the door.
5. Set the control switch to the desired temperature. Even if the oven heats up quickly, pre-heating for about 10 minutes is still recommended. The oven should reach its full temperature within 15 - 20 minutes.
6. Switching off: Turn the control switch until the line on the switch is in line with the dot on the instrument panel.

6.6.6 Folding console to extend the kitchen counter-top



Fig. 187: Folding console to extend the kitchen counter-top

Depending on the model, a folding console may be installed as an extension of the kitchen counter-top.

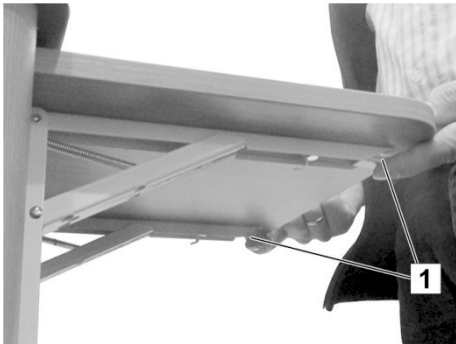

Fig. 188: Undoing the latching mechanism

Opening the folding console

- Lift the folding console upward until both latches (1) have latched.

Folding the folding console

- Push both latches (1) upward at the same time and fold the console downward.

6.6.7 Absorber refrigerator for operation with 12 V, 230 V and gas (option)

NOTE



Prior to first use and cleaning, and when parking for longer periods (e.g. winter break) read the accompanying operating manual provided by the manufacturer of the refrigerator!

Overview

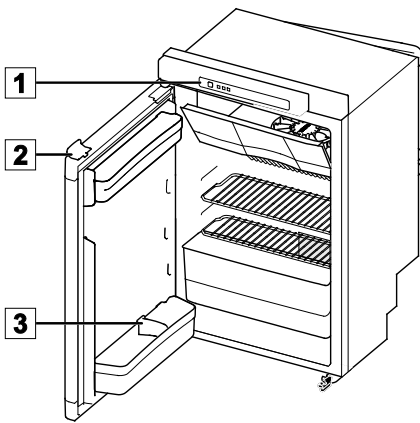

Fig. 189: Thetford Model A refrigerator

The refrigerator can be operated with 12V, 230V or with gas.

- To prevent discharging the supply battery, do not use the 12V battery when the engine is running.
- Gas ignition at altitudes higher than 1000 m above sea level may be disturbed - this is not a malfunction but a reaction to changed pressure levels.
- The refrigerator works trouble-free at inclines to approximately 5°.
- Attach the winter cover for winter operation.
- To open, press the door lock (2) on the upper edge of the refrigerator door downward and swing the door open.

LED operating panel (1)

- A ON-OFF switch
- B Operating button
- C Arrow buttons
- D Power source symbols
- E Cooling level indicators
- F "Anti-condensation" symbol (only Model B)
- G "Batteries empty" symbol (optional)

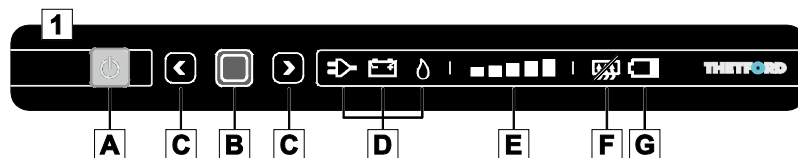

Fig. 190: LED operating panel

Activating the refrigerator

1. Press the ON-OFF switch (A) for one second. The integrated lamp illuminates green.
2. The LED operating panel dims after ten seconds. The green lamp indicates that refrigerator is operating.

Selecting the power source

1. After activating the refrigerator, press the operating button (B) for two seconds. The power source symbols (D) are flashing.
2. Select the desired power source by pressing the arrow buttons (C).
3. Press the operating button (B) to confirm your selection.

Selecting the cooling level

1. After activating the refrigerator, press the operating button (B) for two seconds. The power source symbols (D) are flashing.
2. Press again the operating button.
3. The cooling level indicators (E) are flashing. Select the desired cooling level by pressing the arrow buttons (C).
4. Press the operating button (B) to confirm your selection.

On the road

Close the refrigerator and push against the refrigerator door to automatically lock the door. The door lock (1) also secures the door during the drive.

NOTE

Ensure that all objects in your refrigerator are well secured against shifting. Secure bottles in the door with the bottle holder (3) and ensure that foodstuff in the shelves is fastened.

Deactivating the refrigerator

- Press the ON-OFF switch (A) for two seconds. All lamps at the LED operating panels extinguish.

7 Maintenance

Proper care requires the right cleaner for the various materials. This applies to both the exterior and interior of the vehicle. To maintain an overview of the variety of materials used, we have compiled a list of the materials, their properties and the requirements for the appropriate cleaner in a table in the appendix.

CAUTION



Damage due to use of the incorrect cleaner!

Use of incorrect cleaning agents may result in damage to the surface being cleaned.

- Always observe the manufacturer's instructions for diluting the cleaner.
 - Before using the cleaner, compare the pH value with the information in our table.
-

7.1 Exterior cleaning

NOTE



Acrylic glass window panes are very sensitive and require special care.

Only clean wet with a clean sponge or soft cloth.

Avoid using chemical cleaning agents, glass cleaner and other aggressive cleaners.

Use special acrylic glass cleaner for stubborn stains.

1. Prior to cleaning the vehicle, close all doors, windows, and skylights.
2. Apply a weak water jet to the entire caravan at an approved vehicle washing facility.
3. Wash the vehicle with a soft sponge and mild shampoo solution and rinse with water.
4. Dry the caravan (e.g. with a chamois); remove, in particular, moisture on lamp holders, window frames, etc.
5. Treat the surfaces with a suitable preserving agent.

NOTE



Because GFRP surfaces age faster than coated surfaces, they may become dull and attract moss and algae growth. For this reason, GFRP surfaces must be polished and sealed with wax at least once year to be protected against UV light and ageing. Suitable polishes and sealants are available from specialist distributors for camping and water sports products.

6. Plastic parts such as bumpers and skirting panels should be cleaned with off-the-shelf, non-aggressive plastic cleaning agents.
7. Apply a rubber care agent (talcum for example) to rubber door and window elements.
8. Grease door hinges, stabilisers and joints as needed.

Maintenance

7.2 Interior cleaning

1. Use standard, non-aggressive household cleaning and care products for the interior and floor.
2. Wipe off furniture surfaces with a damp cloth, use furniture polish if necessary.
3. Vacuum off the upholstery or clean it carefully with a mild foam cleaner. Do not wash.
4. Thoroughly rinse and disinfect the fresh water tank and fresh water lines, empty and clean the waste water tank.
5. Use designated non-abrasive steel cleaners to clean the sink and hob to avoid scratching.
6. Use designated plastic cleaning and care products to clean plastic parts such as shower and washbasin.
7. No aggressive cleaning agents containing solvents or alcoholic substances should be used to clean the 3D thick edges in the furnished area.

7.3 Pop-up roof (optional)

Care tips for the hinged pop-up roof

- Treat the roof bellows with an off-the-shelf impregnating agent each year before the start of the season.
- Thoroughly vent the roof bellows several times a year, to prevent stagnant moisture and musty odour.
- Do not fold the pop-up roof in damp or wet condition immediately after rainfall, for example.
- Rub a suitable separating agent (e.g. talcum) into the sealing rubber on the roof shell before winter, so that the sealing rubber does not freeze to the vehicle body in freezing temperatures.
- Treat the roof shell with GRP polish.
- Check the strap bands of the roof locking mechanism for faultless condition and function before each trip. Replace torn belt straps before starting the trip.
- Prior to longer periods of non-use, remove the bed pad from the hinged pop-up roof to avoid stagnant moisture and rotting.

7.4 Measures during lay-up

- Take the following measures.
- Supplemental tasks for winter care are indicated by the letter **W**.
- Amend this list to meet your specific requirements.

Component	Activity	
Chassis		
	Park the caravan where it is safe and secure it from rolling off. Do not engage the parking brake.	
	Thoroughly clean under-body, repair rust and paint damage.	
	Check the air in the tyres, inflate to specified pressure.	
	If possible, jack up the vehicle, otherwise move the vehicle every 4 weeks to prevent pressure marks on tyres and wheel bearings.	
Caravan body		
Exterior	Free the entire vehicle, particularly the roof, from deposits such as branches, leaves, snow and ice.	
	Thoroughly clean the superstructure, repair rust and paint damage.	
	Clean and lubricate the hinges on doors and hatches.	W
	Treat locks with graphite dust.	W
	Rub talcum into the sealing rubber.	W
Interior	If possible, remove the upholstery from the caravan and store it in a dry location; if this is not possible, put it in a vertical position for better ventilation.	W
	Remove clothing, objects of daily use, cosmetics, canned goods and perishable goods from closets, storage areas and compartments.	
	Clean all closets, storage areas, and compartments with a damp cloth.	
	Remove groceries and drinks from the refrigerator. Defrost and clean the refrigerator. Arrest the refrigerator in a position that ensures an air gap.	
	Set up air de-humidifiers.	W
	Repeatedly and thoroughly ventilate the interior.	W

Maintenance

Component	Activity	
Electrical system	Check the supply battery (optional), fill, recharge if necessary.	
	Remove the supply battery (optional) and store it in a frost-free location.	W
	Spray contact spray into the contacts of the plug connector for connection to the towing vehicle.	
Water system	Empty the fresh water tank, open the tank locking mechanism.	
	Drain the hot and cold water system, open all water cocks to middle position and leave them open.	
	Blow out any water remaining in the water lines with compressed air (oil-free, max. 0.5 bar).	
	Empty the siphons in the kitchen and bathroom area.	W
	Empty and clean the waste water tank.	
Sanitary system	Flush the toilet.	
	Empty and clean the waste holding tank.	
Heater	Remove water from the boiler. Open the drain valve.	
Gas supply	Close the gas bottle valves and remove the gas bottles from the gas fastening belt.	
	Close the quick-action valves.	

8 Maintenance

General

Maintenance includes inspection, servicing and repair.

Service tasks described in the sections below are required for optimal and trouble-free vehicle operation.

- In the event that increased wear is detected for specific components in the context of regular inspections, shorten the required service intervals based on the actual wear indications!

In addition to this operating manual, the operating manuals supplied for the built-in devices also apply. The instructions contained therein - particularly the safety instructions cited in these manuals - must be complied with!

If you have questions concerning service work and intervals: Contact the manufacturer (service address → page 2).

WARNING



Danger of accident and injury due to improper maintenance!

Improper maintenance or repair can cause serious accidents or injuries.

- Have repairs to the vehicle or chassis, electrical system, gas system and gas consumers performed only by authorised specialists.

Maintenance

8.1 Inspection and servicing

Inspection and servicing are used to assess actual conditions and recreate recommended states. They are due depending on the mileage or the time period, starting at the time of transfer of ownership or upon first registration.

8.1.1 Mileage/time dependence

Interval	Component	Action required
After 50 km	Wheel	Tighten the wheel nuts
After 500 km	ALKO axle: if the brakes do not automatically self-adjust (optional)	Check and if necessary adjust the brake system
After 5,000 km or after 12 months	ALKO axle: if the brakes do not automatically self-adjust	Check and if necessary adjust the brake system
	ALKO axle: AAA Premium Brake (optional)	Check brake system
After 10,000 km or after 24 months	ALKO axle: if the brakes do not automatically self-adjust	Servicing of the brake system
	ALKO axle: AAA Premium Brake (optional)	Servicing of the brake system
After 15,000 km or after 36 months	ALKO axle: if the brakes do not automatically self-adjust (optional)	Check and if necessary adjust the brake system
	ALKO axle: AAA Premium Brake (optional)	Check brake system
After 20,000 km or after 48 months	ALKO axle: if the brakes do not automatically self-adjust (optional)	Servicing of the brake system
	ALKO axle: AAA Premium Brake (optional)	Servicing of the brake system

NOTE



Thereafter, perform the specified operations alternately every 5,000 km or every 12 months.

8.1.2 Fixed time interval

Interval	Component	Action required
Monthly	Tyres	Check air pressure
	Fresh water tank, grey water tank and fresh water system	Clean and descale
Every six months (e.g. in spring and autumn)	RCD test switch	Press button, check operation
	Stabiliser (AKS) coupling: Check the wear indicator of the stabilising device	. If the wear limit has been reached, replace the friction elements of the stabilising device.
Annually (every spring)	Overall vehicle	Leak test
	Support elements: Threaded rods	Grease
	Doors, service hatches	Grease hinges
	Electrical system	Function check
	Support wheel: Spindle	Grease
every 2 years	Overall vehicle	General vehicle inspection
	Gas system	Gas check according to G 607
	ALDE hot water heater (optional)	Replacement of the glycol-water mixture

Maintenance

8.2 Wheels and tyres

General

WARNING

**Danger to life due to incorrect tyre pressure!**

Incorrect tyre pressure causes excessive wear and tear and damages the tyre which ultimately could burst.

- Prior to every trip or in two-week intervals, check the tyre pressure in cold tyres.
-

- The vehicle is fitted with tubeless tyres. Never install tubes in these tyres.
- When using aluminium rims, you cannot use snow chains.
- In the event of a flat tyre, move the rig to the right (continent) or left (UK) side of the road. Secure the rig with a warning triangle. Activate the hazard warning lights.
- Due to the design, vehicles with tandem axle may exhibit higher tyre wear.
- Tyres must not be older than six years as the material starts to break down. The four-digit DOT at the tyre side indicates the date of manufacture. The first two digits identify the week, the latter two the year of manufacture.
- Regularly (every fortnight) inspect the tyres for even tread abrasion, tread depth, and outer damages.
- Comply with the legal minimum tread depth.
- Always use tyres of the same model, same manufacturer and same type (summer or winter tyres).
- After having installed new tyres, use only moderate speeds for approx. 100 km in order for them to develop optimum grip properties.

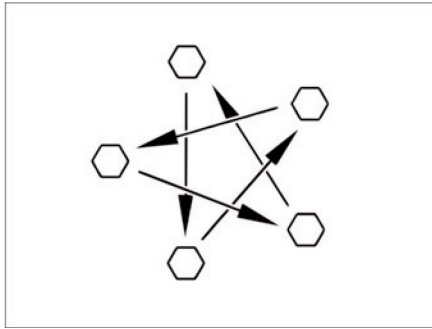

Fig. 191: Always tighten tyre nuts and bolts crosswise

- Regularly check tyre bolts and nuts for proper seating. Re-tighten the nuts or bolts of a replacement after 50 km driving (crosswise sequence, see Fig. 191).
See section "Tightening torques" for the correct tightening torque.
- If you use new or repainted rims, re-tighten the tyre nuts or bolts again after 1000 to 5000 km.
- If the vehicle is not used for extended times, prevent pressure marks at tyres and wheel bearings. Jack up the vehicle to remove stress on the tyres, or move the vehicle every four weeks to change the wheel position.

Tyre selection

WARNING



Danger to life due to incorrect tyre selection!

Incorrect tyre selection causes may damage the tyres during driving, and they may burst.

- Use only tyres that are approved for your vehicle.

- Using tyres not approved for the specific vehicle will cancel the operating licence and ultimately the insurance coverage. Consult your authorised distributor or service point.

The tyre sizes approved for your vehicle are shown in the vehicle documents or can be requested from your authorised distributor or service point. Every tyre must fit the vehicle at which it is to be used. This applies to external dimensions (diameter and radius) indicated by the standardised size designation. But the tyres must also meet the requirements of the respective vehicle regarding weight and speed.

Maintenance

The weight is governed by the maximum permissible axle load to be distributed over two tyres (do not load one-sided). The maximum bearing capacity of a tyre is specified by its load index (= LI load bearing capacity identifier).

The permissible top speed for a tyre (at full load capacity) is specified by its speed rating (= GSY, speed code). Load index and speed rating together form the operational tyre code. It is an official component of the complete and standardised dimension identifier to be found on the tyre itself. The data on the tyre must match those in the vehicle documentation.

Tyre codes

Example: 215/70 R 15C 109/107 Q

Code	Explanation
215	Tyre width in mm
70	Tyre height to width ratio in percent
R	Tyre design (R = radial)
15	Rim diameter in inches
C	Commercial (transporter)
109	Lead bearing code, single tyre
107	Load bearing code, twin tyre
Q	Permissible speed symbol (Q = 100 mph/160 km/h)

Treating tyres properly

- Drive over curbs at an obtuse angle. The tyres may possibly be jammed at the flank. Driving over curbs at an acute angle may cause damage to the tyre and subsequently bursting.
- Drive slowly over elevated manhole covers. The tyres may possibly be jammed. Fast driving over elevated manhole covers may cause damage to the tyre and subsequently bursting.
- Have the shock absorbers inspected regularly. Driving with poor shock absorbers causes significantly higher wear and tear.
- Avoid wheel locking when braking. This can cause the tyres to become more or less brake plates and reduces driving comfort. It can also cause the tyres to become unusable.
- Never clean tyres with a high-pressure washer. They can be damaged within just a few seconds and may subsequently burst.

Maintenance

8.2.1 Changing wheels

General

The spare wheel (optional) is stored in the draw-bar box. Use an off-the-shelf scissor jack to change wheels.

WARNING



Danger to life due to rolling or falling of the vehicle!

Severe injuries can be the result if the vehicle rolls or falls when a wheel is changed.

- The vehicle must stand on level, solid, and non-slipping ground.
 - Fully engage the parking brake prior to lifting the vehicle.
 - Use wheel chocks on the opposite vehicle side to secure it against rolling.
 - Never lift the vehicle with the supports installed.
 - Never place the jack at the superstructure, but only under the axle.
 - Never overload the jack. The maximum permissible load is shown on the jack's nameplate.
 - Use the jack only for a short-time lifting of the vehicle for the purpose of changing the tyre.
 - Never lay under the lifted vehicle.
 - If you have installed aluminium rims and have to use a steel spare wheel: Do not drive longer than necessary to reach the next distributor, workshop or tyre dealer. Adjust your driving speed. The different wheel will adversely affect the driving behaviour.
-

- Do not damage the thread of the gudgeon when changing wheels.
- Always tighten tyre nuts and bolts crosswise.
- If you switch to different rims (e.g. aluminium rims or winter tyres), use the corresponding wheel bolts with correct length and head shape. The proper seating of the wheels and the functioning of the brake system depend on this.
- Rims and tyres not approved for the vehicles can adversely affect its roadworthiness.
- Secure a stranded vehicle according to the national regulations, e.g., warning triangle, flares, etc.
- Prior to changing the wheel, check the rim size and tyre size, the tyre load bearing capacity and the speed index shown on the tyre. Use only rim and tyre sizes specified in the vehicle documentation.

Tightening torque

Rim	Tightening torque [Nm]
Steel rim	90
Aluminium rim	120

Preparation



Fig. 192: Securing the support wheel



Fig. 193: Securing the vehicle

Maintenance

Preparing the coupled caravan

- In caravan couplings with a stabilisation device, loosen the stabilisation device. The friction linings will be overstressed otherwise.
- Engage the parking brake of the towing vehicle and shift to first gear.

Preparing the uncoupled caravan

- Park the vehicle on as level and firm a ground as possible.
- Engage the parking brake
- turn the support wheel diagonally to the driving direction and secure with suitable means (Fig. 192).

Jack

Risk of injury when changing a wheel.

Always ensure that:

- The jack base must securely rest on the ground.
- Do not tilt the jack.
- Always insert the profile of the AL-KO lift jack (optional) to the stop in the retaining pocket.



Fig. 194: Off-the-shelf jack

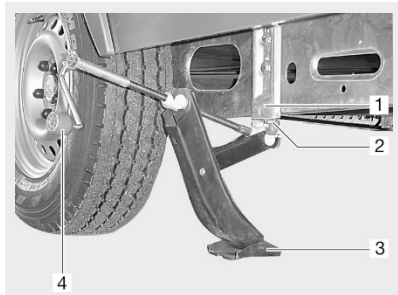

Fig. 195: AL-KO lift jack

Procedure

1. To secure the vehicle, use wheel chocks or similar object on the opposite wheel (Fig. 193).
2. Remove the spare wheel (optional) from its bracket.
3. In the case of soft ground, place a stable base (e.g., wooden board) under the jack.
4. Position the jack.
 - a Off-the-shelf jacks:
Position the scissor jack (Fig. 194) or hydraulic jack at the frame or the axle.
 - b AL-KO automotive jack (optional):
Insert the profile (Fig. 195, Pos 2) of the AL-KO lift jack to the stop in the retaining pocket (Fig. 195, Pos 1). Hold the jack with one hand, and turn the crank (Fig. 195, Pos 4) clockwise until the base plate (Fig. 195, Pos 3) touches the ground and stands evenly.
5. Use a ratchet wrench to loosen the wheel bolts, but do not remove them!
6. Lift the vehicle until the wheel is two to three cm (just over one inch) above ground.
7. Remove the wheel bolts and take off the wheel.
8. Place the spare wheel (optional) on the hub and align.
9. Insert the wheel bolts and lightly tighten crosswise.
10. Crank down and remove the jack.
11. Use the ratchet wrench to evenly tighten the wheel bolts.

Changing a wheel with an aluminium rim

- The bearing surfaces of the wheel on the brake drums must be clean and free of burrs.
- Lightly tighten the wheel, using only the supplied fastening means, and check for proper bearing and operating clearance. Use a torque wrench to crosswise tighten the wheel bolts.
- Various axle designs do not have a centring aid, collar or bolts. Ensure that the wheel bolts are evenly centred across the bore circle (no canting).

Maintenance

8.2.2 Tyre pressure table

Tyre type	Technically permissible total weight [kg] for vehicles with		Tyre pressure [bar]
	Single axle	Tandem axle	
185/70 R14 LI88	≤ 900	1800	2.60
	1000	2000	2.80
	1100	2200	2.80
185 R14C LI102	≤ 1100		3.30
	1200		3.30
	1300		3.50
	1400		3.80
	1500		4.25
	1600	2800	4.50
195/65 R14 LI89	≤ 1000	2000	2.50
	1100	2200	3.00
195/65 R15 LI91	≤ 1000	2000	2.50
	1100	2200	2.70
195/65 R15XL LI95	≤ 1100	2000	2.50
	1200	2200	2.80
	1300	2500	3.10
195/70 R14 LI91	≤ 1000	2000	2.50
	1100	2200	2.70
195/70 R14XL LI95	≤ 1100	2000	2.50
	1200	2200	2.80
	1300	2500	3.10

Tyre type	Technically permissible total weight [kg] for vehicles with		Tyre pressure [bar]
	Single axle	Tandem axle	
195/70 R14XL LI96	≤ 900	1800	2.50
	1000	2000	2.50
	1100	2200	2.50
	1200		2.70
	1300	2500	3.00
195 R14C LI106	≤ 1100		3.00
	1200		3.00
	1300		3.20
	1400		3.40
	1500		3.75
	1600	2800	4.00
	1700		4.50
	1800	3500	4.50
205/70 R15C LI106	≤ 1100	2000	3.00
	1200	2200	3.00
	1300	2500	3.20
	1400		3.50
	1500		3.80
	1600	2800	4.00
	1700		4.20
	1800	3500	4.50

Maintenance

Tyre type	Technically permissible total weight [kg] for vehicles with		Tyre pressure [bar]
	Single axle	Tandem axle	
205 R14C LI109	≤ 1600		3.70
	1700		4.00
	1800	3500	4.25
	1900		4.50
215/55 R16XL LI97	≤ 1100		2.70
	1200		2.70
	1300		3.00
	1400		3.00
215 R14C LI112	≤ 1600		3.30
	1700		3.50
	1800	3500	3.80
	1900		4.00
	2000		4.30
225/70 R15C LI112	≤ 1100	2000	3.00
	1200	2200	3.00
	1300	2500	3.00
	1400		3.00
	1500		3.00
	1600	2800	3.50
	1700		3.50
	1800	3500	3.70
	1900		4.00
	2000		4.30

Tyre type	Technically permissible total weight [kg] for vehicles with		Tyre pressure [bar]
	Single axle	Tandem axle	
215/55 R17XL LI98	≤ 1400		3.20
215/60 R17C LI109	≤ 1700		4.00
	1800		4.50
	1900		4.50
	2000		4.75

Maintenance

8.3 ALDE heating maintenance overview

Date	Maintenance task	Distributor or service centre
	<input type="checkbox"/> Changing the glycol/water mixture <input type="checkbox"/> Heating system vented in cold state <input type="checkbox"/> Heating system vented in warm state	Stamp, signature
	<input type="checkbox"/> Changing the glycol/water mixture <input type="checkbox"/> Heating system vented in cold state <input type="checkbox"/> Heating system vented in warm state	Stamp, signature
	<input type="checkbox"/> Changing the glycol/water mixture <input type="checkbox"/> Heating system vented in cold state <input type="checkbox"/> Heating system vented in warm state	Stamp, signature
	<input type="checkbox"/> Changing the glycol/water mixture <input type="checkbox"/> Heating system vented in cold state <input type="checkbox"/> Heating system vented in warm state	Stamp, signature
	<input type="checkbox"/> Changing the glycol/water mixture <input type="checkbox"/> Heating system vented in cold state <input type="checkbox"/> Heating system vented in warm state	Stamp, signature
	<input type="checkbox"/> Changing the glycol/water mixture <input type="checkbox"/> Heating system vented in cold state <input type="checkbox"/> Heating system vented in warm state	Stamp, signature
	<input type="checkbox"/> Changing the glycol/water mixture <input type="checkbox"/> Heating system vented in cold state <input type="checkbox"/> Heating system vented in warm state	Stamp, signature
	<input type="checkbox"/> Changing the glycol/water mixture <input type="checkbox"/> Heating system vented in cold state <input type="checkbox"/> Heating system vented in warm state	Stamp, signature
	<input type="checkbox"/> Changing the glycol/water mixture <input type="checkbox"/> Heating system vented in cold state <input type="checkbox"/> Heating system vented in warm state	Stamp, signature
	<input type="checkbox"/> Changing the glycol/water mixture <input type="checkbox"/> Heating system vented in cold state <input type="checkbox"/> Heating system vented in warm state	Stamp, signature
	<input type="checkbox"/> Changing the glycol/water mixture <input type="checkbox"/> Heating system vented in cold state <input type="checkbox"/> Heating system vented in warm state	Stamp, signature

Date	Maintenance task	Distributor or service centre
	<input type="checkbox"/> Changing the glycol/water mixture <input type="checkbox"/> Heating system vented in cold state <input type="checkbox"/> Heating system vented in warm state	Stamp, signature
	<input type="checkbox"/> Changing the glycol/water mixture <input type="checkbox"/> Heating system vented in cold state <input type="checkbox"/> Heating system vented in warm state	Stamp, signature
	<input type="checkbox"/> Changing the glycol/water mixture <input type="checkbox"/> Heating system vented in cold state <input type="checkbox"/> Heating system vented in warm state	Stamp, signature
	<input type="checkbox"/> Changing the glycol/water mixture <input type="checkbox"/> Heating system vented in cold state <input type="checkbox"/> Heating system vented in warm state	Stamp, signature
	<input type="checkbox"/> Changing the glycol/water mixture <input type="checkbox"/> Heating system vented in cold state <input type="checkbox"/> Heating system vented in warm state	Stamp, signature
	<input type="checkbox"/> Changing the glycol/water mixture <input type="checkbox"/> Heating system vented in cold state <input type="checkbox"/> Heating system vented in warm state	Stamp, signature
	<input type="checkbox"/> Changing the glycol/water mixture <input type="checkbox"/> Heating system vented in cold state <input type="checkbox"/> Heating system vented in warm state	Stamp, signature
	<input type="checkbox"/> Changing the glycol/water mixture <input type="checkbox"/> Heating system vented in cold state <input type="checkbox"/> Heating system vented in warm state	Stamp, signature
	<input type="checkbox"/> Changing the glycol/water mixture <input type="checkbox"/> Heating system vented in cold state <input type="checkbox"/> Heating system vented in warm state	Stamp, signature
	<input type="checkbox"/> Changing the glycol/water mixture <input type="checkbox"/> Heating system vented in cold state <input type="checkbox"/> Heating system vented in warm state	Stamp, signature
	<input type="checkbox"/> Changing the glycol/water mixture <input type="checkbox"/> Heating system vented in cold state <input type="checkbox"/> Heating system vented in warm state	Stamp, signature

Malfuncions

9 Malfuncions

General

This chapter provides information about troubleshooting. Malfuncions for which causes and remedies are not explained here must be corrected by an authorised workshop.

Additional information concerning malfuncions is also provided in the operating manuals for the built-in devices. If the malfunction correction measures described in those manuals are not successful, then contact an authorised workshop.

WARNING



Danger of accident and injury due to improper troubleshooting!

Improper troubleshooting can cause serious accidents and injuries.

- Have repairs to the electrical system, gas system and gas consumers only performed by authorised specialists.

9.1 Caravan body

Malfunction	Cause	Remedy
Exterior:		
Hinges on the outside door, storage and service hatches do not move easily	Insufficient hinge lubrication	Lubricate hinges with acid-free and resin-free grease
Interior:		
Hinges and joints in the bathroom, the storage compartments and cupboard do not move easily	Insufficient hinge/joint lubrication	Lubricate hinges and joints with acid-free and resin-free grease

9.2 Electrical system

DANGER



Life-threatening danger due to electric shock!

Touching live components can cause serious or fatal injury.

- Prior to any work, switch off the electrical system and disconnect from the mains supply.
- Switch off the ELCB.

9.2.1 Malfunctions in standard equipment

Malfunction	Cause	Remedy
No 230 V mains power, although system is connected	Power cable is not connected	Connect the power cable.
	230 V miniature circuit breaker in the caravan has tripped	Determine the defect and correct it; if necessary go to a workshop, then switch on the 230 V circuit breaker
	The 230 V fuse of the camp site has tripped	Have the 230 V at the camp site checked and switched on by the facility attendant.
12 V power supply does not work during 230 V operation	MCB is not switched on	Activate the MCB
	Automatic 230 V circuit breaker has tripped	Have the electrical system checked by a specialised workshop.
Lighting system does not function or does not function completely	Lighting fixture is defective	Replace the lighting fixture, comply with voltage and watt specifications
	The fuse for the lighting circuit is defective	Identify the defect and correct it; if necessary, visit a workshop, then replace the fuse

Malfunctions

9.2.2 Faults of the stand-alone package (optional)

Malfunction	Cause	Remedy
Supply battery does not charge with 230 V connection	Charger defective	Contact a specialist workshop
	Charging current fuse defective	Identify the defect and correct it; if necessary, visit a workshop, then replace the fuse
12 V power supply does not work during 230 V operation	230 V circuit breaker has tripped	Have the electrical system checked by a specialised workshop.
	Disconnect switch of supply battery turned off	Switch on the disconnect switch
12 V power supply does not work during 12 V battery operation	Circuit breaker switched off	Activate the MCB
	Supply battery discharged	Recharge the supply battery
	Charging current fuse defective	Identify the defect and correct it; if necessary, visit a workshop, then replace the fuse
	Disconnect switch of supply battery turned off	Switch on the disconnect switch
	Charger defective	Contact a specialist workshop
Supply battery does not charge during driving	Charger defective	Contact a specialist workshop
No voltage at the supply battery	Supply battery discharged	Immediately charge the supply battery; prevent total discharge

9.2.3 Changing light bulbs

DANGER



Life-threatening danger due to electric shock!

Danger of electric shock potentially resulting in serious or fatal injury when working on electrical equipment.

- Any repair tasks on the electrical system must be performed by qualified personnel.
- Replace defective fuses only after the cause of the fault has been identified and rectified.

Light bulb change

Changing light bulbs is simple. Depending on the model:

1. Carefully open and remove the housing.
 2. Unscrew the dead bulb from the socket and replace with a new bulb.
 3. Carefully place and close the housing.
- If there are defects in the lighting fixtures that you cannot correct yourself, visit a customer service facility!

Replacing LEDs



Fig. 196: Replacing LEDs

1. Carefully open and remove the housing.
 2. Remove dead LED from the socket.
 3. If necessary, shorten the contact of the new LED to a length of 10 to 15 mm and insert.
 4. Carefully place and close the housing.
- If there are defects in the lighting fixtures that you cannot correct yourself, visit a customer service facility!

ATTENTION



Risk of fire due to incorrect light bulbs!

Using halogen bulbs may overheat the lap fixture and cause a fire.

- Replace LEDs only with LEDs of the same type.

Malfunctions

Replacing the bulb of the rear lamp unit



Fig. 197: Rear lamp assembly mounting

1. Pull the chrome strip (A) off from the rear lamp assembly towards the rear.

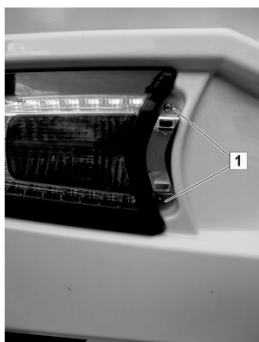

Fig. 198: Remove the rear lamp assembly

2. Use a screwdriver to remove the screws (1) of the rear lamp assembly.
3. Carefully swivel the rear lamp assembly.

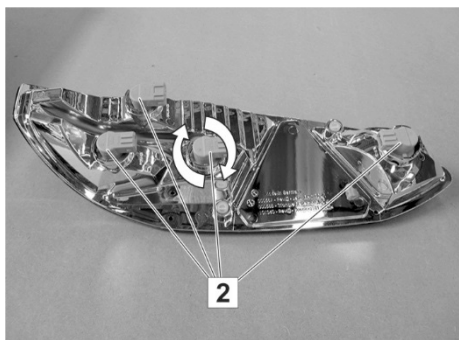

Fig. 199: Rear lamp assembly (rear)

4. Remove the bulb socket (2). Turn the bayonet mechanism to the zero position and pull off the socket.
5. Replace the bulb.
6. Insert the bulb socket (2) in the rear lamp assembly. Position the bayonet mechanism in the zero position, push and as far as it will go.

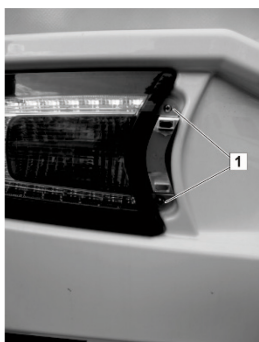

Fig. 200: Reattaching the rear lamp assembly

7. Carefully insert the rear lamp assembly.
8. Use a screwdriver to tighten the two screws (1) of the rear lamp assembly.
9. Insert the chrome strip.

9.2.4 Changing the smoke detector battery

The smoke detector is fitted with a 9 V block battery. To maintain the function of the smoke detector, the block battery must be replaced regularly, at the latest when the battery indicator signal sounds.

- Comply with the safety and operating instructions in the operating manual provided by the manufacturer!



Fig. 201: Removing the housing

1. Carefully rotate the housing of the smoke detector counter-clockwise (15° approximately) until it can be taken from the bracket.



Fig. 202: Replacing the block battery

2. Remove the spent block battery and disconnect it from the contact strip.
3. Connect the new block battery with the contact strip. The contact strip must engage on the poles of the block battery.
4. Insert the connected new battery in the battery compartment of the smoke detector.

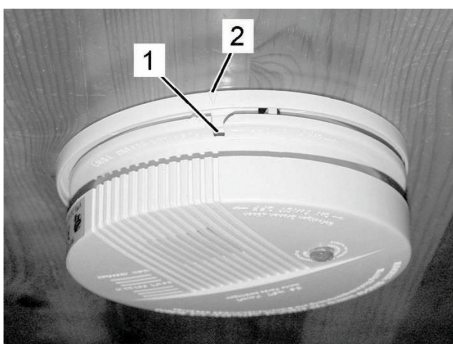

Fig. 203: Replacing the housing

5. place the smoke detector's housing with the notch (1) at the mark (2) and strongly press onto the bracket.
6. Carefully rotate the housing clockwise (15° approximately) until it latches in the bracket.

Malfunctions

9.3 Gas supply

WARNING



Danger of injury due to escaping gas!

Escaping gas can explode.

- All repair work must be performed by an authorised gas specialist workshop.
- If gas odour is detected:
 - Immediately shut down the gas supply.
 - Do not operate any electric devices.
 - Remove fire and sources of ignitions.
- Do not smoke.

Malfunction	Cause	Remedy
Gas odour or higher gas consumption	Gas supply leaks	Have a specialist workshop inspect and repair the gas supply system
Gas device does not function	Quick-action valve closed	Open the quick-action valve
	Gas bottle valve closed	Open the gas bottle valve
	Outside temperature too low for camping gas	Only use propane if outdoor temperatures are low
	Gas device defective	Contact a specialist workshop

9.4 Hob

Malfunction	Cause	Remedy
No flame when igniting	Gas bottle valve or quick-action valve is closed	Open the gas bottle valve and quick-action valve
	Gas bottle empty	Replace gas bottle
Flame extinguishes immediately after the regulator is released	Warm-up period too short	Keep the rotary knob depressed for approximately 10 seconds after ignition.
	Safety pilot is defective	Contact a specialist workshop
Flame extinguishes when it is reduced	Safety pilot sensor is defective	Contact a specialist workshop

9.5 Heater and hot water

9.5.1 Malfunctions, TRUMA heater

Malfunction	Cause	Remedy
Red indicator light, "Malfunction", is illuminated	Lack of gas	Open the gas bottle valve and quick-action valve Connect a full gas bottle
	Air in the gas line system	Switch off the heater and switch it on again. After two unsuccessful ignition attempts, wait for 10 minutes and try again
Green indicator light is not illuminated	Fuse defective	Identify the defect and correct it; if necessary, visit a workshop, then replace the fuse
Fan propeller of the gas heater is noisy or does not run evenly	Fan propeller is fouled	Contact a specialist workshop

Malfunctions

9.5.2 Malfunctions, ALDE heater

Malfunction	Cause	Remedy
Battery low	Battery voltage in vehicle below 10.5 V (heater shuts down)	Charge battery (automatic reset as soon as the voltage is again above 11 V)
Fan failure	Wrong fan speed	Automatic reset after 5 minutes
Gas failure	No gas supply.	Switch off and restart the heater, visit specialist workshop, if necessary.
Overheating red	Triggered by overtemperature protection (red cable)	Disconnect and reconnect the 12 V power supply
Overheating blue	Triggered by overtemperature protection (blue cable)	Disconnect and reconnect the 12 V power supply
Window open	An opened window forces the heater to close the gas supply (electric heater continues)	Close the window
Connection failure	Connection fault between heater and operating panel	Switch off and on the main power for the heater; if necessary, visit specialist workshop.
Panel failure 1	Panel error	Contact a specialist workshop
Panel failure 2	Panel error	Contact a specialist workshop

9.6 Refrigerator

Malfunction	Cause	Remedy
Refrigerator does not switch on:		
at 230 V mains operation	Circuit breaker has tripped	Determine the defect and correct it; if necessary go to a workshop, then switch on the circuit breaker.
	230 V operating voltage is too low	Have the 230 V system checked by a specialised workshop
At 12 V operation	12 V power supply from the towing vehicle does not function	Check the supply lines, e.g. coupling connectors, for damage or contact problems
	230 V operating voltage is too low	Have the 230 V system checked by a specialised workshop
	Battery empty	Replace battery
at gas operation	Lack of gas	Open the gas bottle valve and quick-action valve
		Connect a full gas bottle

Malfunctions

9.7 Fresh water and waste water system

Malfunction	Cause	Remedy
Water leaks in the vehicle	Fresh water system or waste water system leaks	Identify leak points, repair the leaks
No fresh water	Freshwater tank empty	Fill the fresh water tank
	Water pump fuse defective	Identify the defect and correct it; if necessary, visit a workshop, then replace the fuse
	Water pump filter clogged	Clean or replace filter
	Water pump defective	Replace the water pump
	12 V supply defective	Contact a specialist workshop
Turbidity, changes in taste and/or smell of the fresh water Deposits in the fresh water tank or in the lines	Tank has been filled with contaminated water	Clean the water system mechanically and chemically; disinfect the water system and flush thoroughly with drinking water
	Residues in the tank or fresh water system	
	Microbiological deposits in the fresh water system	
	Untreated fresh water has been in the system too long	
No toilet flushing water	Freshwater tank empty	Fill the fresh water tank
Incorrect display of the filling level in the fresh water tank	Filling level sensor in the fresh water tank is fouled	Clean the filling level sensor, or have it replaced by a specialised workshop.
	Filling level sensor defective	
Water does not drain in the shower, washbasin or kitchen sink	Siphon plugged	Clean siphon

10 Tightness guarantee

10.1 Guarantee certificate

The guarantee certificate for your vehicle was given to you by your authorised distributor when the vehicle was transferred to you. This guarantee is only valid if it has been signed by the buyer and the authorised distributor.

- Keep the guarantee certificate in a safe place!

10.2 Guarantee conditions and terms

1. LMC guarantees tightness for the duration of 6 six years for models manufactured in or after 2014, and 12 years for models with the Long Life Technology (LLT series from year of manufacture 2015) special option - but maximal up to 120.000 km in total - undertaking that the manufactured vehicle is sealed in a manner that no moisture will penetrate the interior at usual stresses. The buyer is incumbent to provide evidence for a leak at the vehicle. The buyer has no claims arising from this guarantee if the leaks can be traced to improper handling of the vehicle or improperly repaired damages to the same. Moreover, damage that is caused by natural forces (e.g. flood or hail) is excluded.
2. If a leak occurs, LMC shall be obligated within the framework of these guarantee conditions to repair the vehicle parts in question through no-charge repair or replacement of parts, depending on the steps necessary to immediately eliminate the damage. Defects shall be repaired by LMC or by an authorised LMC workshop in accordance with the guidelines specified by LMC. A claim for damage compensation or for elimination of damages arising as a consequence of the first defect does not exist, except in the event that the damage can be traced to gross negligence or wrongful intent by LMC.
3. The guarantee shall be in effect at the date of initial registration or transfer of the vehicle to the buyer, but at the latest one year following the delivery of the vehicle to the dealership. It shall be in force for the duration of the usability of the vehicle, but at the most for six years for models manufactured in or after 2014, and 12 years for models with the Long Life Technology (LLT series from year of manufacture 2015) special option, but maximal up to 120.000 km in total. If the object of purchase changes hands, the guarantee obligations shall remain unaffected. The guarantee expires if the annual inspections specified in item 4 are not performed. The performance of guarantee work does not extend the duration of the guarantee itself.
4. Prerequisite for this guarantee is that the vehicle be annually inspected for leaks by an authorised LMC dealer. The inspection must be performed between the 11th and 13th month after the anniversary of the initial registration (or transfer). The buyer can claim compensation under this guarantee only if he is able to provide evidence of proper performance of the annual inspection by an authorised LMC

Tightness guarantee

- dealer. The inspection certificate completed by the authorised LMC dealer confirmed with an authorisation by LMC (inspection mark number) must be provided.
5. The owner must report the occurrence of leaks or moisture indicating potential leaks in writing to LMC or an authorised LCM dealer within 15 days. The guarantee certificate must be attached to this report.
 6. No claim arising from this guarantee shall be accepted if the leak is not reported in a timely manner as indicated above. Claims for compensation under this guarantee shall not be accepted if damages to the vehicle shell detected during the inspections are not remedied immediately by the buyer.
 7. Type and scope of the elimination of leaks are determined solely by LMC or the authorised LMC dealer.
 8. Tightness inspections are subject to a charge. The costs for the inspection are borne by the customer.
 9. No claims against LMC arise from the guarantee or liability for material defects in the case of natural wear and damages arising from improper handling or impermissible modifications of the vehicle.
Guarantee claims and material defect liability claims are also excluded if damage occurs to the vehicle that can be attributed to parts and accessories not authorised by LMC or that are due to non-compliance with the repair and maintenance guidelines specified by the manufacturer.
 10. To the extent legally permissible, Sassenberg shall be agreed as the place of jurisdiction.

10.3 Inspection schedule and inspection certificates

Verification

NOTE



The annual tightness tests are prerequisite for the tightness guarantee for the caravan body.

Verification of inspection must be completed by your authorised dealer after every executed test; it must be entered in the On-line system and printed for you.

Tightness guarantee

10.3.1 Overview of the extent of the leak inspections

Visual inspections - interior	✓
Entry section	
Front wall including connections on the floor plate and side walls	
Rear wall including connections on the floor plate and side walls	
Left side wall including connections on the floor plate and side walls	
Right side wall including connections on the floor plate and side walls	
Wheel housings left and right	
Roof cut-outs	
Visual inspections of the motor home's outside	✓
Exterior sheet metal	
Edge seals	
Under-body	
Damages to the exterior shell	

Measurements

Measured values up to 20 % are considered normal. For measured values greater than 20 %, check whether condensation has accumulated.

Measurement	Measured value
Floor measurements on the connecting points of the front/rear/side	
Measurements in the interior: walls, window apertures, roof hatch, cable conduit, etc.	

Spray with special sealant

Sealed points/edges	✓
Wheel housing	
Cut-out edges in the floor plates	
Butt joints	
Installation openings in the under-body	

11 Appendix

Interior and exterior material care

Exterior cleaner	Material	Properties	Suitable	Unsuitable
Cleaning the paint surface	Polyester paint	Water-resistant, hard, scratch-sensitive, UV-sensitive	Cleaner for exterior painted surfaces	Acetone, solvent, thinners, scouring agents
Cleaning of acrylic glass panes	Acrylic glass	Scratch-sensitive, soft	Acrylic glass cleaner	Acetone, solvent, thinners, scouring agents, window cleaner, alcoholic cleaners
Cleaning of GFRP formed parts (gelcoat)	Coloured polyester resin or epoxy resin	Water-resistant, soft, scratch-sensitive, UV-sensitive	Cleaners/polishes for GFRP	Acetone, solvent, thinners, scouring agents
Cleaning of the aluminium-framed doors and flaps	Anodised or painted aluminium	Scratch-sensitive, soft	Mild cleaner for exterior painted surfaces	Aggressive cleaners for outdoor use with pH values > 9
Cleaning of plastic parts	ABS with PMMA (acrylic)	Scratch-sensitive, soft	Mild cleaner for exterior plastics	Aggressive cleaners for outdoor use with pH values > 9 acetone, solvent, thinners, scouring agents, window cleaner, alcoholic cleaners
Care of rubber seals	EPDM	Scratch-sensitive, soft	Mild cleaner for exterior use	Aggressive cleaners for outdoor use with pH values > 9 acetone, solvent, thinners, scouring agents, window cleaner, alcoholic cleaners

Appendix

Interior cleaner	Material	Properties	Suitable	Unsuitable
Floor cover	PVC, vinyl	Soft, abrasion resistant	Mild cleaner for plastics	Aggressive cleaners for toilets or tiles with pH values > 9 acetone, solvent, thinners, scouring agents, window cleaner, alcoholic cleaners, floor wax
Cleaners for shower trays, splash guards	Polystyrene	Scratch-sensitive, soft	Mild cleaner for plastics	Aggressive cleaners for toilets or tiles with pH values > 9 acetone, solvent, thinners, scouring agents, window cleaner, alcoholic cleaners
Toilet	Polypropylene	Robust, scratch-resistant	Cleaners recommended by the toilet manufacturer, see operating manual	Aggressive cleaners for toilets or tiles with pH values > 9 acetone, solvent, thinners, scouring agents, window cleaner, alcoholic cleaners
Sink/cooker	Anodised steel sheet, stainless steel sheet	Strong, abrasion-resistant, scratch-sensitive, stainless	Dishwasher detergent, vinegar-based cleaner	Acetone, solvent, thinners, window cleaner, alcoholic cleaners
Kitchen worktops, tabletops	High density melamine-faced compressed boards (Resopal-HPL)	Robust, scratch-resistant, temperature-resistant, dirt-resistant	Dishwasher detergent, vinegar-based cleaner	Acetone, solvent, thinners, scouring agents

Interior cleaner	Material	Properties	Suitable	Unsuitable
Furniture	Coated plywood, possibly real wood	Soft, not abrasion-resistant, scratch-sensitive	Damp cloth with water or a mild detergent	Acetone, solvent, thinners, scouring agents, window cleaner, alcoholic cleaners
Upholstery fabrics	Velours, microfibres, woven fabrics	Sensitive, depending on the type of fabric	Damp cloth with water or a mild detergent, brush	Acetone, solvent, thinners, scouring agents, window cleaner, alcoholic cleaners

Index

12 Index

- A**
Adjusting the LED spot light 149
AGM battery 87
Air-conditioning 66
Airing 122
ALDE heater 101, 132
Appendix 205
Awning fastening 70
- B**
Bathroom 74, 75, 154
Bathroom lighting 149
Battery charge status 89
Blackout blind 65, 66, 124
- C**
Camping 112
Canopy light 93
Caravan body 32, 56, 190
Changing light bulbs 193
Changing wheels 180
Check list 37
Cleanliness 31
Combination blind 65, 124
Convector 103
Coupling 39, 42
Crocery 77
- D**
Door lock 59
Driving 34
- E**
Electrical system 26, 83
Entrance door 56, 57
Environmental protection 10, 31
Equipment, technical 83
Exhaust gas stack 100
Explanation of symbols used 9
Extending and retracting the support elements 53
Exterior cleaning 169
- F**
Filling levels 105
Fire safety 15
Floor heating 105, 131
Flushing the toilet 154, 156
Fly screen 65, 66, 124
Fly screen door (SW) 125
Folding console as bed extension 145
Folding console to extend the kitchen counter-top 165
Forced ventilation 66
Fresh water 106
 draining 114
 Fresh water tank 107
 intake port 106
 tank cap 106
Fresh water tank
 filling 112
Furnishings 74
- G**
Gas bottles
 Single-bottle operation 121
 Switching 121
Gas box 61, 96
Gas cooker 77
Gas heater 99, 127
Gas heating
 Battery change 130
 Cleaning 131
 Closing the heater grille 130
 Removing the heater grille 130
Gas pressure regulator 120
Gas supply 23, 95, 96, 97
Guarantee 201

H

Hatch lock 57
Hatch locks 59
Heater 99, 101
Heating 127
Heating the floor 104
Hinged window 62, 123
 Locking 63
Hot water boiler 59
Hot-air nozzle 100, 131

I

Inspection 174
Inspection certificate 203
Inspection schedule 203
Intended use 12
Interior cleaning 170
Interior lighting 91
Introduction 7

K

Keys 11, 56
Kitchen 77
 Lower cabinet 77
 upper cabinet 80
Kitchen area 158
Kitchen light 149

L

Lay-up 171
LED 193
LED displays 72
LED switches 72
Light bulb change 193
Light switch 71
Load 20, 34
Loading 34
Loads 33
Low pressure regulator 96

M

Maintenance 168, 173

Maintenance hatch 59

Malfunction 190

 Stand-alone package (optional) 192

Malfunctions

 cooking hob 196
 electrical system 191
 fresh water and waste water 200
 gas supply 196
 heater, hot water 197
 light bulbs 193
 refrigerator 199

Multifunction light switch 71

N

Nameplate 33

O

Operational reliability 23
Overview 55

P

Parking 51
Pop-up roof 68, 150, 170
Power connection 112
Power outlets 94

R

Rear external storage locker 59
Rear lamp unit 194
Rearranging the cushions 146
Remote control 93
Remote display 98, 121
Responsibility of the vehicle owner 13
Room thermostat 129

S

Safety 12
 after the road trip 22
 Before the trip 21
 brakes 18
 dimensions and weight 16
 electrical 26
 fire safety 15

Index

- Gas devices 24
- gas supply 23
- general requirements 14
- on the road 22
- Rig operation 17
- sanitary system 29
- vehicle equipment 19
- Safety and warning signs 9
- Sanitary system 29
- Servicing 174
- Setting up the lighting 149
- Shower 75
- Sink 77
- Sitting 142
- Sitting area 74
- Skylight 66, 126
- Skylights 66
- Sleeping 142
- Sliding windows 64, 123
- Smoke detector 73, 195
- Stabiliser system 45
- Stand-alone package 88
- Storage
 - under-bed 79
- Storage compartment
 - mirror cabinet 81
 - wall cupboards 80
 - washbasin cabinet 81
- Storage compartments 79
 - Kitchen 77
- Storage space
 - kitchen 80
- Supply battery 86
- System Information Unit 95
- T**
- Technical data 32
- Technical documentation 8
- Technical equipment 83
- Toilet 76
- Toilet chemistry 31
- Traffic safety 16
- Trailer 17
- Travelling and parking 50
- TRUMA heater 99, 127
- TV bracket 82
- Tyre pressure table 184
- Tyres 18, 176
- U**
- Uncoupling 44
- V**
- Vehicle
 - Checking the 38
 - loading 34
 - parking 22
 - stopping 22
- Vehicle documents 8
- Vehicle license 11
- Vehicle registration 11
- W**
- Wall cupboards 80
- Wall exhaust stack 102
- Washbasin 74
- Waste 31
- Waste holding tank 59
- Waste water 31, 106, 109
- Waste water tank 74
- Water drain valve 111
- Water heater 110, 139
- Water heating 74
- Wheels 18, 176
- Window 62
- Window switch 103

